



## SA100



### General Description

The SA100 is a socket mounting type temperature controller and is available for mounting inside panel by easily mounting on DIN rail. The SA100 has features such as analog retransmission output, advanced self-tuning, alarms, digital communications for networking and digital contact for SV1/SV2 or RUN/STOP functions..

### Features

- ☆ Simple mounting on DIN Rail
- ☆ Corresponding to various applications
- ☆ Analog retransmission output
- ☆ Digital communications
- ☆ Advanced self-tuning

#### Simple Mounting on DIN Rail

The SA100 can be simply mounted on DIN rail with DIN rail mounting socket. The maintenance is also simple, as the unit can be removed from socket.

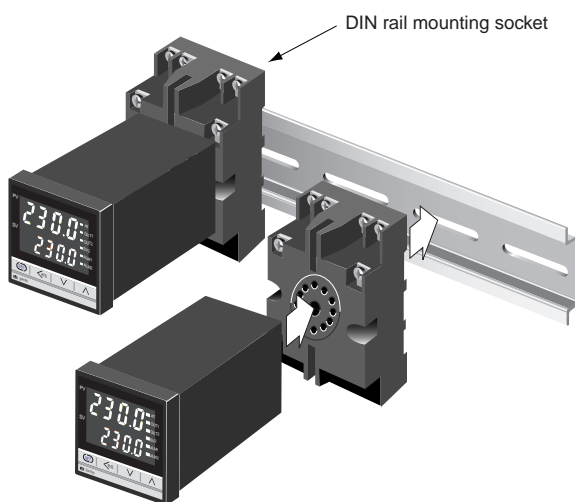

- The rear terminal socket allows the unit to be mounted on a panel board.

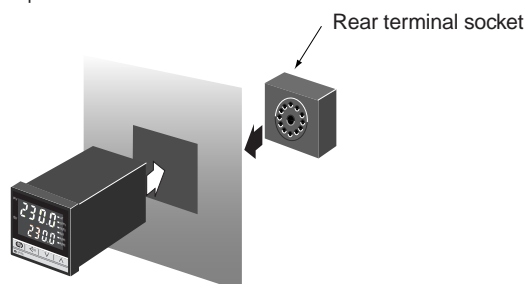

#### Corresponding to Various Applications

Two points of output can be used as control, alarm or analog retransmission. The SA100 corresponds to various applications such as temperature controller and overheat protection unit.

- As a temperature controller
  - 1. Temperature alarm controller
 

	OUT1 → Control output
	OUT2 → Alarm output
  - 2. Temperature retransmitting controller
 

	OUT1 → Retransmission output
	OUT2 → Control output
  - 3. Heat/Cool temperature controller
 

	OUT1 → Heating output
	OUT2 → Cooling output
- As an overheat protection unit or alarm unit
  - 1. Overheat protection unit
 

	OUT1 → Control output
	* Setting to ON/OFF action by specifying direct action.
  - 2. Overheat protection unit with transmitting function
 

	OUT1 → Retransmission output
	OUT2 → Control output
	* Setting to ON/OFF action by specifying direct action.
  - 3. Alarm unit
 

	OUT1 → Alarm output
	OUT2 → Alarm output

- The change of display for PV/SV can be configurable. For the details of it, contact our sales office.

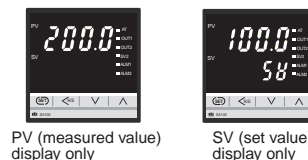

PV (measured value) display only

SV (set value) display only

The SV is displayed on PV display. Parameters are displayed on SV display.

#### Analog Retransmission Output (Optional)

An analog output is available so that the process value can be retransmitted an analog signal to a remote instrument such as a recorder or data-logging equipment.

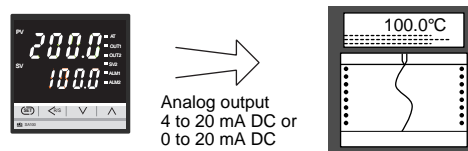

Analog output  
4 to 20 mA DC or  
0 to 20 mA DC

# Digital Temperature Controller SA100

## Features

### Alarms (Optional)

Two alarm points can be configured for specific applications.

#### Alarm Type

- Temperature Alarm
  - Deviation High, Deviation Low, Deviation High/Low, Band, Process High, Process Low
  - (Hold action can be added to deviation and process type)
- Set Value Alarm
  - High, Low
- Loop Break Alarm

Temperature Alarm		Δ : SV	▲ : Alarm
Deviation High	OFF → ON	Δ	▲
(Alarm Set Value is a positive (+) setting)			
Deviation Low	ON → OFF	▲	Δ
(Alarm Set Value is a negative (-) setting)			
Deviation High/Low	ON → OFF → ON	▲	▲
(Alarm Set Value is the absolute deviation value)			
Band	OFF → ON → OFF	▲	▲
(Alarm Set Value is the absolute deviation value)			
Process High	OFF → ON	▲	▲
Process Low	ON → OFF	▲	▲
Set Value Alarm		Δ : SV	
Set Value High	OFF → ON	Δ	
Set Value Low	ON → OFF	Δ	

### Heat/Cool Control (Optional)

The Heat/Cool PID control features heat and cool outputs for use where process-generated heat exists. This allows the input of overlap or deadband settings which contribute to energy savings.

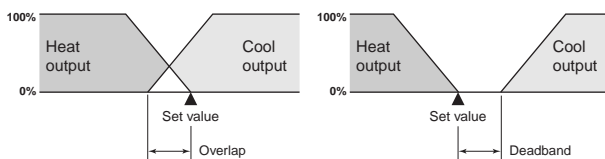

### Digital Communications (Optional)

The SA100 offers an optional RS-485 communications interface for networking to computers, PLCs and SCADA software. MODBUS or ANSI protocol can be selected. Up to 32 units, including host computer, can be multi-dropped on one RS-485 communication line. When the communication feature is selected, the external contact input is not available.

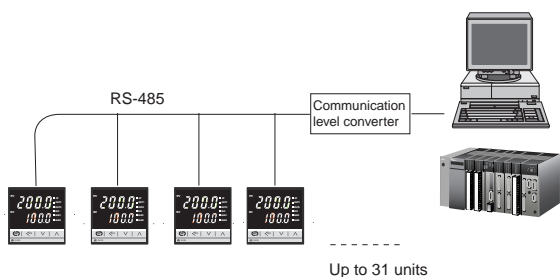

### Digital Contact Input for External Switching (Optional)

An optional digital contact input is available for RUN/STOP and SV1/SV2 switching. (RUN/STOP switching can also be completed at the front key panel.) This function can be used with the output from a timer, PLC, etc. When the communication feature is selected, the external contact input is not available.

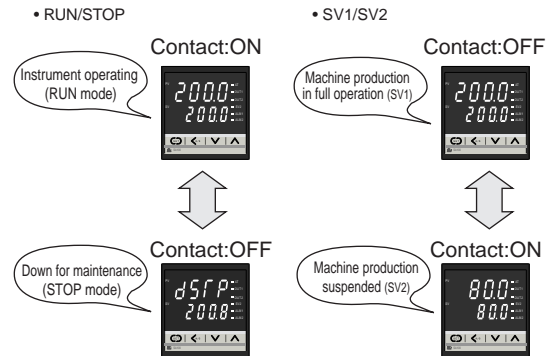

### Self-Tuning Algorithm

The SA100 offers a new self-tuning feature that is initiated at start-up and when process parameters or conditions change. In these situations, the controller evaluates whether the preset PID parameters should be maintained or replaced by the latest self-tuning parameters to achieve the best control for the process. Self-tuning can be manually turned ON/OFF in the parameter setting mode. This feature is not available with the Heat/Cool control.

In addition to self-tuning, The SA200 has standard autotuning (AT) so that either function can be selected to achieve optimum process control.

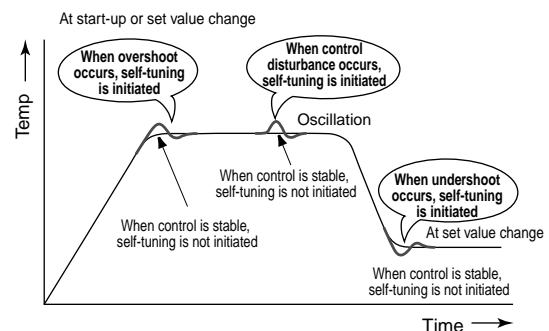

## Specifications

### Input

#### Input

- a) Thermocouple : K, J, E, T, R, S, B, N (JIS/IEC), PLII (NBS) W5Re/W26Re(ASTM), U, L (DIN)
- Input impedance : Approx. 1M $\Omega$
  - Influence of external resistance : Approx. 0.2 $\mu$ V/ $\Omega$
  - Input break action : Up-scale
- b) RTD : Pt100(JIS/IEC), JPt100(JIS)
- Influence of lead resistance : Approx. 0.01[%/ $\Omega$ ] of reading
  - Maximum 10 $\Omega$  per wire
  - Input break action : Up-scale
  - Input short action : Down-scale
- c) DC voltage : 0 to 5V DC, 1 to 5V DC, 0 to 10V DC
- d) DC current : 0 to 20mA DC, 4 to 20mA DC
- For DC current input, connect a 250  $\Omega$  resistor to the input terminals.
  - Refer to the Input and Range and Input Code Table for details.
  - Input break action : Down-scale
  - Both Heat/Cool control outputs are OFF for Heat/Cool PID action.
  - Reading is around zero for 0 to 5V DC input, 0 to 10V DC input and 0 to 20mA DC input.

#### Sampling Time

0.5 sec.

#### PV Bias

- span to +span (Within -1999 to 9999)

### Performance

#### Measuring Accuracy

- a) Thermocouple
- $\pm$ (1% of reading + 1 digit) or  $\pm$ 2°C (4°F) whichever is larger
  - Accuracy is not guaranteed between 0 and 399°C (0 and 799°F) for type R, S and B.
  - Accuracy is not guaranteed less than -100.0°C (-158.0°F) for type T and U.
- b) RTD
- $\pm$ (0.3% of reading + 1 digit) or  $\pm$ 0.8°C (1.6°F) whichever is larger
- c) DC voltage and DC current
- $\pm$ (0.3% of span + 1 digit)

#### Insulation Resistance

More than 20M $\Omega$  (500V DC) between measured terminals and ground  
More than 20M $\Omega$  (500V DC) between power terminals and ground

#### Dielectric Strength

1000V AC for one minute between measured terminals and ground  
1500V AC for one minute between power terminals and ground

### Control

#### Control Method

- a) PID control (with autotuning and self-tuning function)
- Available for reverse and direct action. (Specify when ordering.)
  - ON/OFF, P, PI and PD control are also selectable.
  - ON/OFF action differential gap : 2°C(°F) (Temperature input) 0.2% (Voltage, current input)
- b) Heat/Cool PID control (with autotuning function)
- Air cooling and water cooling type are available. (Specify when ordering.)

#### Major Setting Range

Set value : Same as input range.  
Heat side proportional band : 1 to span or 0.1 to span (ON/OFF action when P=0)  
Cool side proportional band : 0 to 1000% of heat side proportional band  
Integral time : 0 to 3600sec. (PD action when I=0)  
Derivative time : 0 to 3600sec. (PI action when D=0)  
Anti-Reset Windup(ARW) : 1 to 100% of heat side proportional band (Integral action is OFF when ARW=0)  
Proportional cycle time : 1 to 100 sec.  
Deadband/Overlap : -span to +span (Within -1999 to 9999)

### Outputs

#### Output

- Can be set for control, alarm or retransmission functions.
- Alarm output can be set for energized/de-energized action.
- Alarm output can be set for AND/OR logic calculation.

Number of outputs : 2 points

#### Output Type

- Relay contact output : 250V AC 2A (resistive load), Form C contact  
Voltage pulse output : 0/12V DC (Load resistance : more than 600 $\Omega$ )
- Measurement terminals and output terminal are not isolated.
- Current output : 0 to 20mA, 4 to 20mA DC (Load resistance : less than 400 $\Omega$ )
- Measurement terminals and output terminal are not isolated.

### Alarms (Up to 2 points)

(Optional)

#### Alarm Type

Deviation High, Deviation Low, Deviation High-Low, Deviation Band  
Process High, Process Low, Set value High, Set value Low  
Loop break alarm(LBA)

#### Setting Range

- a) Deviation alarm : -span to +span (Within -1999 to 9999)  
b) Process alarm : Same as set value (SV).  
c) Set value alarm : Same as set value (SV).  
d) Loop break alarm : 0.0 to 200.0 min.

#### Differential Gap

2°C (°F) or 2.0°C (°F) (Temperature input), 0.2% (Voltage, current input)

### Contact Input

(Optional)

Number of Inputs : 2 points

#### Contact Input Type

- a) RUN/STOP switching (OPEN : STOP, CLOSE : RUN)  
b) STEP function (OPEN : SV1, CLOSE : SV2)

#### Input Rating

Non-voltage contact input. (OPEN : 500k $\Omega$  or more, CLOSE : 10 $\Omega$  or less)

### Communications

(Optional)

- a) Communication method : Based on RS-485 (2-wire)  
b) Communication speed : 2400, 4800, 9600, 19200 BPS  
c) Protocol : ANSI X3.28(1976) 2.5 A4 MODBUS
- d) Bit format
- Start bit : 1
  - Data bit : 7 or 8 •For MODBUS 8 bit only
  - Parity bit : Without, Odd or Even
  - Stop bit : 1 or 2
- e) Communication code : ASCII(JIS) 7-bit code  
f) Maximum connection : 31 ( Address can be set from 0 to 99.)

### Retransmission Output

(Optional)

Retransmission output is allocated to OUT1.

- a) Type : Process value, Set value, Deviation, Manipulated value  
b) Output type : 0 to 20mA DC, 4 to 20mA DC (Load resistance : less than 400 $\Omega$ )  
c) Output resolution : More than 10bits  
• Measurement terminals and output terminal are not isolated.

### Waterproof/Dustproof

(Optional)

Dustproof and waterproof protection : IP66

- Waterproof/dustproof protection only effective from the front in panel mounted installations.

### General Specifications

#### Supply Voltage

- a) 85 to 264V AC (Including supply voltage variation) [Rating : 100 to 240V AC] (50/60Hz common)  
b) 21.6 to 26.4V AC (Including supply voltage variation) [Rating : 24V AC] (50/60Hz common)  
c) 21.6 to 26.4V DC (Ripple rate 10% p-p or less) [Rating : 24V DC]

#### Power Consumption

Less than 4VA (at 100V AC), 7VA (at 240V AC) for standard AC type  
Less than 4VA for 24V AC type  
Less than 100mA for 24V DC type

#### Power Failure Effect

A power failure of 20 ms or less will not affect the control action.  
If power failure of more than 20 ms occurs, controller will restart.

Operating Environments : 0 to 50°C [32 to 122°F] , 45 to 85% RH

Memory Backup : Backed up by non-volatile memory.  
Number of writing : Approx. 100,000 times

Net Weight : Approx. 120g

External Dimensions (W x H x D) : 48 x 48 x 70mm (1/16 DIN)

### Compliance with Standards

- CE Mark
- UL Recognized
- CSA Certified
- C-Tick Mark





## Model and Suffix Code

### Alarm Code Table

A	Deviation High	B	Deviation Low	C	Deviation High/Low	D	Deviation Band
E	Deviation High with Hold	F	Deviation Low with Hold	G	Deviation High/Low with Hold	H	Process High
J	Process Low	K	Process High with Hold	L	Process Low with Hold	R	Loop break alarm <sup>1</sup>
V	Set value High	W	Set value Low				









































































<sup>1</sup> Loop break alarm is not available with Heat/Cool PID control type.

### Output Allocation Code Table

Code	Specifications		
	Control methods	Output 1	Output 2
0 3	PID control + Alarm 1	Control output	Alarm 1 output (De-energized)
0 4	PID control + Alarm 1, 2	Control output	AND logic output of Alarm 1 and Alarm 2 (Energized)
0 5	PID control + Alarm 1, 2	Control output	OR logic output of Alarm 1 and Alarm 2 (De-energized)
0 6	PID control + Alarm 1, 2	Control output	AND logic output of Alarm 1 and Alarm 2 (De-energized)
0 7	PID control + Alarm 1, 2 or only Alarm 1 <sup>1</sup>	Control output	No output
0 8	PID control + Alarm 1, 2	Control output	Only Alarm 1 output (Energized)
0 9	Alarm 1 + Alarm 2	2 Alarm 1 output (Energized)	Alarm 2 output (Energized)
1 0	Alarm 1 + Alarm 2	2 Alarm 1 output (Energized)	Alarm 2 output (De-energized)
1 1	Alarm 1 + Alarm 2	2 Alarm 1 output (De-energized)	Alarm 2 output (De-energized)
1 2	Retransmission + PID control	Retransmission output	Control output
1 3	Retransmission + Alarm 1, 2	Retransmission output	OR logic output of Alarm 1 and Alarm 2 (Energized)
1 4	Retransmission + Alarm 1, 2	Retransmission output	OR logic output of Alarm 1 and Alarm 2 (De-energized)
1 5	Retransmission + Alarm 1, 2	Retransmission output	AND logic output of Alarm 1 and Alarm 2 (Energized)
1 6	Retransmission + Alarm 1, 2	Retransmission output	AND logic output of Alarm 1 and Alarm 2 (De-energized)
1 7	Retransmission + Alarm 1	Retransmission output	Alarm 1 output (Energized)
1 8	Retransmission + Alarm 1	Retransmission output	Alarm 1 output (De-energized)
1 9	Heat-Cool PID control	Cool output (DC current output)	Heat output (Relay contact or Voltage pulse output)

<sup>1</sup> The alarm monitor can only be confirmed by front LCD display or serial communication.

<sup>2</sup> Specify control action F to use both outputs as alarms.

<p>Standard</p> <p>Output 1</p> <p><input type="checkbox"/> OUT1 </p> <p>Output 2</p> <p>No alarm</p>	<p>Standard</p> <p>Output 1</p> <p><input type="checkbox"/> OUT1 </p> <p>Output 2</p> <p>Energized alarm</p> <p><input type="checkbox"/> ALM1  </p> <p>Alarm ON Alarm OFF</p>	<p>Standard</p> <p>Output 1</p> <p><input type="checkbox"/> OUT1 </p> <p>Output 2</p> <p>Energized alarm</p> <p><input type="checkbox"/> ALM1  </p> <p><input type="checkbox"/> ALM2  </p> <p>*OR* logic Alarm ON Alarm OFF</p>	<p>Standard</p> <p>Output 1</p> <p><input type="checkbox"/> OUT1 </p> <p>Output 2</p> <p>Cool-side</p> <p><input type="checkbox"/> OUT2 </p>	<p>Code 0 3</p> <p>Output 1</p> <p><input type="checkbox"/> OUT1 </p> <p>Output 2</p> <p>De-energized alarm</p> <p><input type="checkbox"/> ALM1  </p> <p>Alarm ON Alarm OFF</p>
<p>Code 0 4</p> <p>Output 1</p> <p><input type="checkbox"/> OUT1 </p> <p>Output 2</p> <p>Energized alarm</p> <p><input type="checkbox"/> ALM1  </p> <p><input type="checkbox"/> ALM2  </p> <p>*AND* logic Alarm ON Alarm OFF</p>	<p>Code 0 5</p> <p>Output 1</p> <p><input type="checkbox"/> OUT1 </p> <p>Output 2</p> <p>De-energized alarm</p> <p><input type="checkbox"/> ALM1  </p> <p><input type="checkbox"/> ALM2  </p> <p>*OR* logic Alarm ON Alarm OFF</p>	<p>Code 0 6</p> <p>Output 1</p> <p><input type="checkbox"/> OUT1 </p> <p>Output 2</p> <p>De-energized alarm</p> <p><input type="checkbox"/> ALM1  </p> <p><input type="checkbox"/> ALM2  </p> <p>*AND* logic Alarm ON Alarm OFF</p>	<p>Code 0 7</p> <p>Output 1</p> <p><input type="checkbox"/> OUT1 </p> <p>Output 2</p> <p>Only display</p> <p><input type="checkbox"/> ALM1</p>	<p>Code 0 7</p> <p>Output 1</p> <p><input type="checkbox"/> OUT1 </p> <p>Output 2</p> <p>Only display</p> <p><input type="checkbox"/> ALM1</p> <p><input type="checkbox"/> ALM2</p>
<p>Code 0 8</p> <p>Output 1</p> <p><input type="checkbox"/> OUT1 </p> <p>Output 2</p> <p>Energized alarm</p> <p><input type="checkbox"/> ALM1  </p> <p><input type="checkbox"/> ALM2  </p> <p>Output alarm 1 only Alarm ON Alarm OFF</p>	<p>Code 0 9</p> <p>Output 1</p> <p>Energized alarm</p> <p><input type="checkbox"/> ALM1  </p> <p>Alarm ON Alarm OFF</p> <p>Output 2</p> <p>Energized alarm</p> <p><input type="checkbox"/> ALM2  </p> <p>Alarm ON Alarm OFF</p>	<p>Code 1 0</p> <p>Output 1</p> <p>Energized alarm</p> <p><input type="checkbox"/> ALM1  </p> <p>Alarm ON Alarm OFF</p> <p>Output 2</p> <p>De-energized alarm</p> <p><input type="checkbox"/> ALM2  </p> <p>Alarm ON Alarm OFF</p>	<p>Code 1 1</p> <p>Output 1</p> <p>De-energized alarm</p> <p><input type="checkbox"/> ALM1  </p> <p>Alarm ON Alarm OFF</p> <p>Output 2</p> <p>De-energized alarm</p> <p><input type="checkbox"/> ALM2  </p> <p>Alarm ON Alarm OFF</p>	<p>Code 1 2</p> <p>Output 1</p> <p>Retransmission</p> <p>Output 2</p> <p></p>
<p>Code 1 3</p> <p>Output 1</p> <p>Retransmission</p> <p>Output 2</p> <p>Energized alarm</p> <p><input type="checkbox"/> ALM1  </p> <p><input type="checkbox"/> ALM2  </p> <p>*OR* logic Alarm ON Alarm OFF</p>	<p>Code 1 4</p> <p>Output 1</p> <p>Retransmission</p> <p>Output 2</p> <p>De-energized alarm</p> <p><input type="checkbox"/> ALM1  </p> <p><input type="checkbox"/> ALM2  </p> <p>*OR* logic Alarm ON Alarm OFF</p>	<p>Code 1 5</p> <p>Output 1</p> <p>Retransmission</p> <p>Output 2</p> <p>Energized alarm</p> <p><input type="checkbox"/> ALM1  </p> <p><input type="checkbox"/> ALM2  </p> <p>*AND* logic Alarm ON Alarm OFF</p>	<p>Code 1 6</p> <p>Output 1</p> <p>Retransmission</p> <p>Output 2</p> <p>De-energized alarm</p> <p><input type="checkbox"/> ALM1  </p> <p><input type="checkbox"/> ALM2  </p> <p>*AND* logic Alarm ON Alarm OFF</p>	<p>Code 1 7</p> <p>Output 1</p> <p>Retransmission</p> <p>Output 2</p> <p>Energized alarm</p> <p><input type="checkbox"/> ALM1  </p> <p>Alarm ON Alarm OFF</p>
<p>Code 1 8</p> <p>Output 1</p> <p>Retransmission</p> <p>Output 2</p> <p>De-energized alarm</p> <p><input type="checkbox"/> ALM1  </p> <p>Alarm ON Alarm OFF</p>	<p>Code 1 9</p> <p>Output 1</p> <p>Cool-side</p> <p><input type="checkbox"/> OUT1 </p> <p>Output 2</p> <p>Heat-side</p> <p><input type="checkbox"/> OUT2 </p>	<p>Note: Relay contact output : 250V AC 2A (resistive load), Form A contact</p> <p></p> <p>Power supply OFF : Open</p>		

### Accessory

Name	Model code
Shunt resistor for DC current input	KD100-55
Terminal cover	KSA200-56A

# Digital Temperature Controller SA100

## External Dimensions and Rear Layout

Units : mm

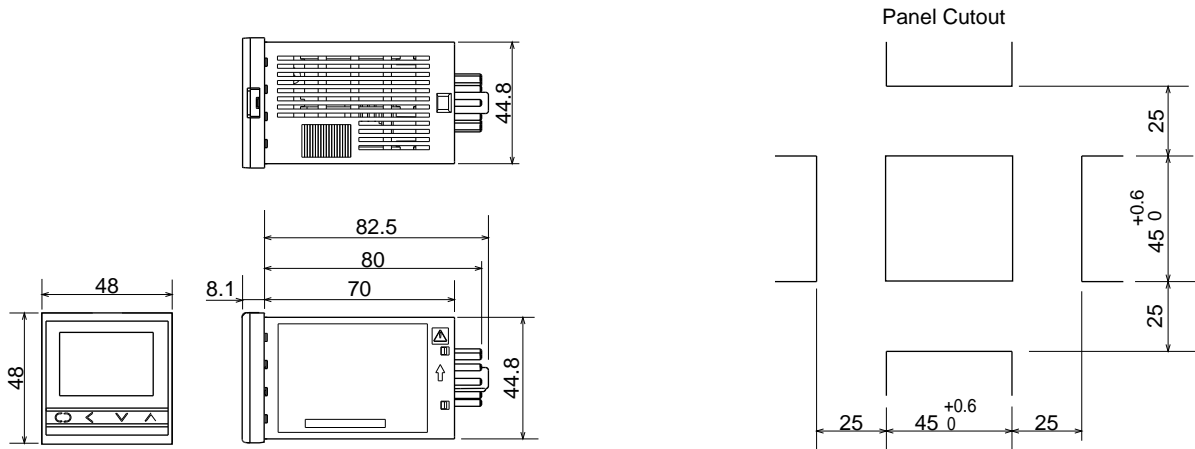

- Panel thickness must be between 1-10mm.
- Mounting frame is optional.

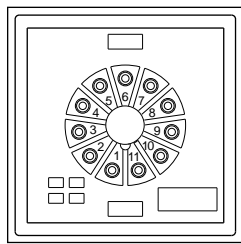

PIN	1	2	3	4	5	6	7	8	9	10	11
Contents											
	① Thermocouple ② RTD ③ Voltage / Current *			① Relay contact ② Voltage pulse ③ DC Current			① Relay contact ② Voltage pulse				
	Measured input			Output 1			Output 2			Power supply	

\*A 250Ω resistor is externally connected at the input terminals.

Communication function and contact input are optional.  
 Connect connector to bottom of instrument.  
 A connector and connector cable for connecting the input block is necessary to be prepared by the customer.  
 Housing: XHP-3 (J.S.T. Mfg. Co., Ltd. product)  
 Recommended cable size: AWG30 to 22

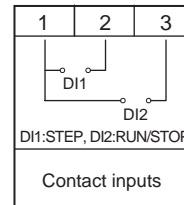
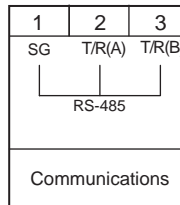

### • Socket (Optional) External Dimensions

DIN rail mounting socket type  
 Model : ATC180041 (Matsushita Denko product)

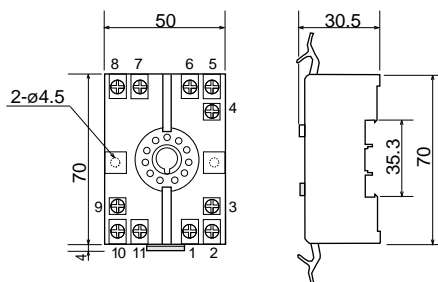

Rear terminal socket type  
 Model : AT78051 (Matsushita Denko product)

