

RTD General Information

General Purpose RTD's

Resistance Temperature Detectors (RTD's) offer an unparalleled combination of quality, performance, and price to meet today's changing market. To meet a broad range of requirements the factory has designed RTD's in three specific temperature ranges: the Low, Medium, and High range series. General specifications, features, and available configurations for each series are as follows:



LOW RANGE: -50 to +200°C (-58 to +392°F)

The construction provides a cost effective and durable probe suitable for industrial process or laboratory applications and offers high accuracy, long term stability, superior interchangeability and resistance to shock and vibration.

Element Types: Platinum 100W, 500W and 1000W ohms at 0°C (standard)
(Nickel, Nickel-Iron and Copper available)

Element Accuracy @ 0°C: + 0.5% to + 0.01% (Multiple DIN, DIN class A and B, Fractional DIN)

Temperature Coef. (TCR): Alpha 0.00375W/°C (1000W), 0.00385W/°C (100W, 500W & 1000W), 0.00392W/°C (100W)

Applicable Standards: DIN/IEC 60751 and JIS C1604

Other Specifications: Consult sales concerning information on stability, repeatability, self-heating and vibration

Sheath Diameters: .050" OD to 3/4" OD (Metric sizes also available)

Sheath Material: 316 stainless steel standard, other materials available

Excitation Current: 1mA or less recommended, 2mA maximum
(Consult sales for applications utilizing more than 2mA)

Insulation Resistance: At 21°C (70°F) with all external surfaces dry, the resistance between any lead wire and the sheath is 500 megohms or greater at 250 VDC.

MEDIUM RANGE: -50 to +450°C (-58 to +842°F)

This series utilizes the same basic construction as the low series, but offers the benefit of an extended temperature range. High accuracy, long term stability, superior interchangeability and resistance to shock and vibration make this series a significant addition to our line of high quality RTD's.

Element Types: Platinum 100W, 500W and 1000W ohms at 0°C (standard)

Element Accuracy @ 0°C: + 0.5% to + 0.01% (Multiple DIN, DIN class A and B, Fractional DIN)

Temperature Coef. (TCR): Alpha 0.00375W/°C (1000W), 0.00385W/°C (100W, 500W & 1000W), 0.00392W/°C (100W)

Applicable Standards: DIN/IEC 60751 and JIS C1604

Other Specifications: Consult sales concerning information on stability, repeatability, self-heating and vibration

Sheath Diameters: 1/8" OD to 3/4" OD (Metric sizes also available)**Sheath Material:** 316 stainless steel standard, other materials available

Excitation Current: 1mA or less recommended, 2mA maximum (Consult sales for applications utilizing more than 2mA)

Insulation Resistance: At 21°C (70°F) with all external surfaces dry, the resistance between any lead wire and the sheath is 100 megohms or greater at 250 VDC.

HIGH RANGE: -200 to +650°C (-328 to +1202°F)

This construction utilizes a fully supported, strain free wire wound sensing element encapsulated in a compacted MgO insulated metal sheathed cable. This combination provides a probe suitable for extremely demanding applications. It offers superior resistance to pressure, shock, and vibration. By utilizing the finest elements available, this style of probe displays long life, longer term accuracy and excellent repeatability.

Element Types: Platinum 100W at 0°C (standard) (Consult for other types)

Element Accuracy @ 0°C: + 0.12% to + 0.01% (DIN class A and B, Fractional DIN)

Temperature Coef. (TCR): Alpha 0.00385W/°C, 0.00392/W°C (100W)

Applicable Standards: DIN/IEC 60751 and JIS C1604

Other Specifications: Consult sales concerning information on stability, repeatability, self-heating and vibration

Sheath Diameters: 1/8" OD to 1/2" OD (Metric sizes also available)

Sheath Material: 316 stainless steel standard, other materials available

Excitation Current: 1mA or less recommended, 5mA maximum

Insulation Resistance: At 21°C (70°F) with all external surfaces dry, the resistance between any leadwire and the sheath is 500 megohms or greater at 250 VDC.

PT100 RTD's Hot Melt Sensor



RTD HIGH TEMP MgO ELEMENTS

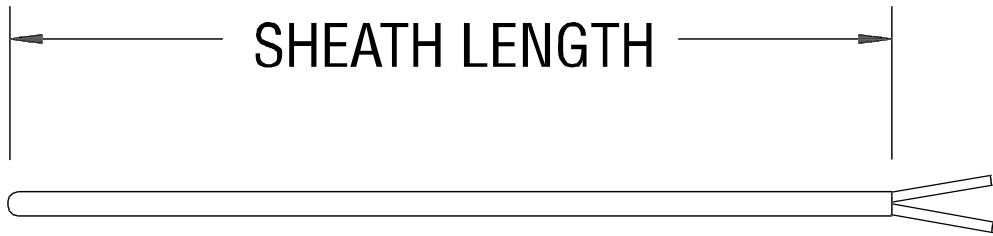

STYLE RA
(HIGH TEMPERATURE CONSTRUCTION ONLY)



SHEATH TERMINATION

A = Stripped Bare Lead
(High Temperature MgO Only)

ELEMENT TYPE

Resistance @ 0°C	2 Wire	3 Wire	4 Wire
Platinum 100Ω Single	A	B	C
Platinum 100Ω Dual	D	E	N/A

ACCURACY & TEMPERATURE COEFFICIENT

Accuracy @ 0°C	Din.00385	Jis.00392
Class B (.12%)	G	H
Class A (.06%)	J	K
1/3 RD (.04%)	M	N
1/10TH (.01%)	Q	N/A

TEMPERATURE RANGE

H = -200 to +650° C

SHEATH DIAMETER (Inch)

G = 1/8 (.125)
I = 3/16 (.188)
K = 1/4 (.250)
N = 3/8 (.375)

STRIP LENGTH

A = 1/4"
B = 1/2"
C = 3/4"
D = 1"
E = 2"
F = 2 1/2"
G = 3"
H = 3 1/2"
I = 4"
J = 4 1/2"
K = 5"

SHEATH LENGTH ("A" Fractional)

A = None G = 1/4 N = 5/8
B = 1/16 J = 3/8 Q = 3/4
C = 1/8 L = 1/2 S = 7/8
E = 3/16

SHEATH LENGTH ("A")

Whole Inches: Example 06 = 6 inches

SHEATH MATERIAL

W = 316 SS

LEADWIRE STYLE RTD's

STYLE B

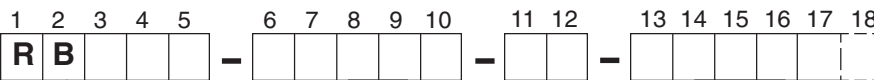
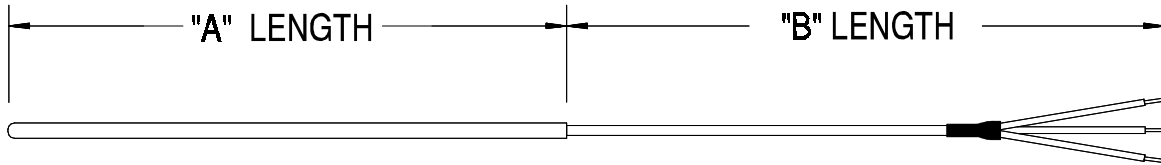

SHEATH TERMINATION

B¹ = Standard Style

ELEMENT TYPE

Resistance @ 0°C	2 Wire	3 Wire	4 Wire
Platinum 100Ω Single	A	B	C
Platinum 100Ω Dual	D	E	N/A
Platinum 500Ω Single	F	G	H
Platinum 1000Ω Single	K	L	M

ACCURACY & TEMPERATURE COEFFICIENT

Accuracy @ 0°C	Din.00385	Jis.00392
Class B (.12%)	G	H
Class A (.06%)	J	K
1/3 RD (.04%)	M	N
1/10TH (.01%)	Q	N/A

TEMPERATURE RANGE

L = -50 to +200° C
M = -50 to +450° C

SHEATH DIAMETER (Inch)

G = 1/8 (.125)
I = 3/16 (.188)
K = 1/4 (.250)
N = 3/8 (.375)

SHEATH MATERIAL

W = 316 SS

SHEATH LENGTH ("A")

Whole Inches: Example 00 = None

SHEATH LENGTH ("A" Fractional)

A = None E = 3/16 L = 1/2 S = 7/8
B = 1/16 G = 1/4 N = 5/8
C = 1/8 J = 3/8 Q = 3/4

SHEATH MOUNTING FITTING

Select from pages #R-19 & R-20
None = 00

SPECIAL OPTIONS

F = BX Connector on Leads
J = PVC Coated Flex Armor
K = Teflon Coated Flex Armor
T = Teflon Encapsulated Sheath

LEADWIRE TERMINATIONS

A = None
B = 2-1/2" Split Leads
C = 2-1/2" Split Leads w/#8 Spade Lugs
D = 2-1/2" Split Leads w/#8 Spade Lugs & BX Connector
E = 2-1/2" Split Leads w/1/4" Push-on Connectors
K = Standard Male Plug (200°C)
L = Standard Plug with Mating Jack
M = Standard Female Jack
Q = Miniature Male Plug
R = Miniature Plug Mating Jack
S = Miniature Female Jack

LEADWIRE LENGTH ("B")

Whole Inches: Example: 048 = 48 Inches

LEADWIRE TYPE

D = Stranded Fiberglass Cable (450°C)
E = Stranded Fiberglass with SS Flex Armor
F = Stranded Fiberglass with SS Overbraid
M = Stranded Teflon Cable (200°C)
N = Stranded Teflon with SS Flex Armor
O = Stranded Teflon with SS Overbraid
P = Stranded Shielded Teflon
S = Stranded PVC (105°C)
1² = Stranded Teflon Singles
9² = Stranded Fiberglass Singles

NOTE: ¹Note: For Replaceable elements (RC) for Thermowells see the Thermowell section of the catalog

²For leads longer than 12", please specify type "D" or "M". Please consult factory for availability of special leadwire.

LEADWIRE STYLE RTD's

STYLE D & E

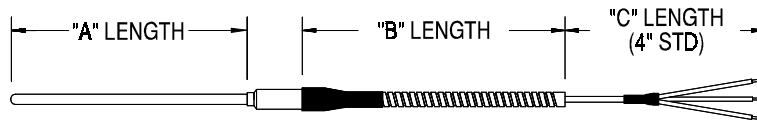

STYLE F & G

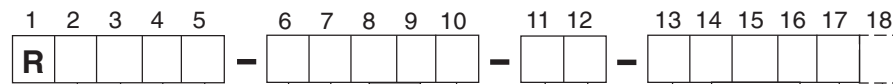
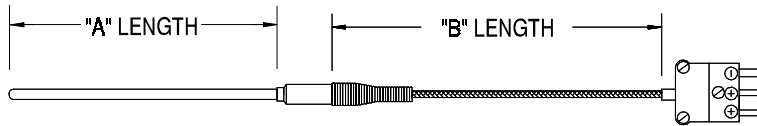

SHEATH TERMINATION

- D = Transition Fitting (200°C)
- E = Hi-Temp Transition Fitting (450°C)
- F = Transition w/ Relief Spring (200°C)
- G = Hi-Temp Transition w/Relief Spring (450°C)

ELEMENT TYPE

Resistance @ 0°C	2 Wire	3 Wire	4 Wire
Platinum 100Ω Single	A	B	C
Platinum 100Ω Dual	D	E	N/A
Platinum 500Ω Single	F	G	H
Platinum 1000Ω Single	K	L	M

ACCURACY & TEMPERATURE COEFFICIENT

Accuracy @ 0°C	Din.00385	Jis.00392
Class B (.12%)	G	H
Class A (.06%)	J	K
1/3 RD (.04%)	M	N
1/10TH (.01%)	Q	N/A

TEMPERATURE RANGE

- L = -50 to +200° C
- M = -50 to +450° C
- H = -200 to +650° C

SHEATH DIAMETER (Inch)

- G = 1/8 (.125)
- I = 3/16 (.188)
- K = 1/4 (.250)
- N = 3/8 (.375)

SHEATH MATERIAL

- W = 316 SS

SHEATH LENGTH ("A")

- Whole Inches: Example 06 = 6 inches

SPECIAL OPTIONS

- F = BX Connector on Leads
- J = PVC Coated Flex Armor
- K = Teflon Coated Flex Armor
- T = Teflon Encapsulated Sheath

LEADWIRE TERMINATIONS

- A = None
- B = 2-1/2" Split Leads
- C = 2-1/2" Split Leads w/#8 Spade Lugs
- D = 2-1/2" Split Leads w/#8 Spade Lugs & BX Connector
- E = 2-1/2" Split Leads w/1/4" Push-on Connectors
- K = Standard Male Plug (200°C)
- L = Standard Plug with Mating Jack
- M = Standard Female Jack
- Q = Miniature Male Plug
- R = Miniature Plug Mating Jack
- S = Miniature Female Jack

LEADWIRE LENGTH ("B")

- Whole Inches: Example: 048 = 48 Inches

NOTE: For leads beyond flex armor ("C" length), include length after "B" length. Example 048 (012)

LEADWIRE TYPE

- D = Stranded Fiberglass (450°C)
- E = Stranded Fiberglass with SS Flex Armor
- F = Stranded Fiberglass with SS Overbraid
- M = Stranded Teflon (200°C)
- N = Stranded Teflon with SS Flex Armor
- O = Stranded Teflon with SS Overbraid
- P = Stranded Shielded Teflon
- S = Stranded PVC (105°C)

SHEATH MOUNTING FITTING

- Select from pages #R-19 & R-20
- None = 00

SHEATH LENGTH ("A" Fractional)

- | | | | |
|----------|----------|---------|---------|
| A = None | E = 3/16 | L = 1/2 | S = 7/8 |
| B = 1/16 | G = 1/4 | N = 5/8 | |
| C = 1/8 | J = 3/8 | Q = 3/4 | |

STANDARD CONNECTOR RTD's

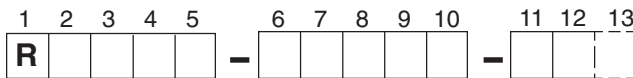

SHEATH TERMINATION

K = Standard Male Plug (200°C)
 L = Standard Plug with Mating Jack
 M = Standard Female Jack

ELEMENT TYPE

Resistance @ 0°C	2 Wire	3 Wire	4 Wire
Platinum 100Ω Single	A	B	C
Platinum 100Ω Dual	D	E	N/A
Platinum 500Ω Single	F	G	H
Platinum 1000Ω Single	K	L	M

ACCURACY & TEMPERATURE COEFFICIENT

Accuracy @ 0°C	Din.00385	Jis.00392
Class B (.12%)	G	H
Class A (.06%)	J	K
1/3 RD (.04%)	M	N
1/10TH (.01%)	Q	N/A

TEMPERATURE RANGE

L = -50 to +200° C
 M = -50 to +450° C
 H = -200 to +650° C

SHEATH DIAMETER (Inch)

G = 1/8 (.125)
 I = 3/16 (.188)
 K = 1/4 (.250)
 N = 3/8 (.375)

SPECIAL OPTIONS

T = Teflon Encapsulated Sheath

SHEATH MOUNTING FITTING

Select from pages #R-19 & R-20
 None = 00

SHEATH LENGTH ("A" Fractional)

A = None G = 1/4 N = 5/8
 B = 1/16 J = 3/8 Q = 3/4
 C = 1/8 L = 1/2 S = 7/8
 E = 3/16

SHEATH LENGTH ("A")

Whole Inches: Example 06 = 6 inches

SHEATH MATERIAL

W = 316 SS

MINIATURE CONNECTOR RTD's

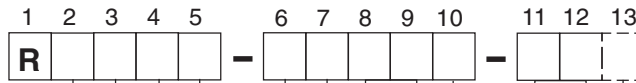
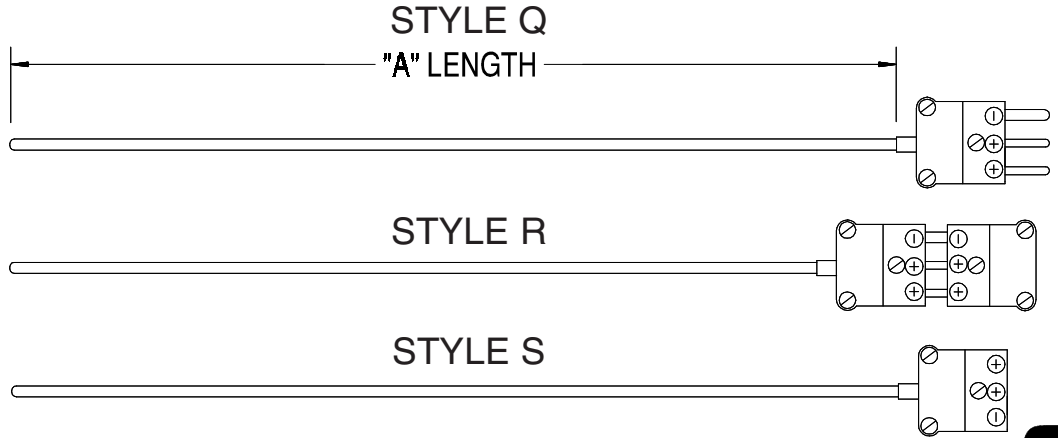

SHEATH TERMINATION

Q = Miniature Male Plug (200°C)
 R = Miniature Plug with Mating Jack
 S = Miniature Female Jack

ELEMENT TYPE

Resistance @ 0°C	2 Wire	3 Wire	4 Wire
Platinum 100Ω Single	A	B	C
Platinum 100Ω Dual	D	E	N/A
Platinum 500Ω Single	F	G	H
Platinum 1000Ω Single	K	L	M

ACCURACY & TEMPERATURE COEFFICIENT

Accuracy @ 0°C	Din.00385	Jis.00392
Class B (.12%)	G	H
Class A (.06%)	J	K
1/3 RD (.04%)	M	N
1/10TH (.01%)	Q	N/A

TEMPERATURE RANGE

L = -50 to +200° C
 M = -50 to +450° C
 H = -200 to +650° C

SHEATH DIAMETER (Inch)

G = 1/8 (.125)
 I = 3/16 (.188)

SPECIAL OPTIONS

T = Teflon Encapsulated Sheath

SHEATH MOUNTING FITTING

Select from pages #R-19 & R-20
 None = 00

SHEATH LENGTH ("A" Fractional)

A = None G = 1/4 N = 5/8
 B = 1/16 J = 3/8 Q = 3/4
 C = 1/8 L = 1/2 S = 7/8
 E = 3/16

SHEATH LENGTH ("A")

Whole Inches: Example 06 = 6 inches

SHEATH MATERIAL

W = 316 SS

SNAP-COVER CONNECTION HEAD RTD's

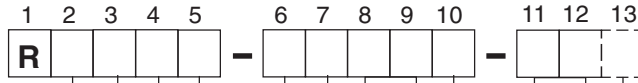
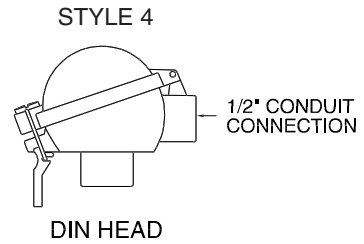
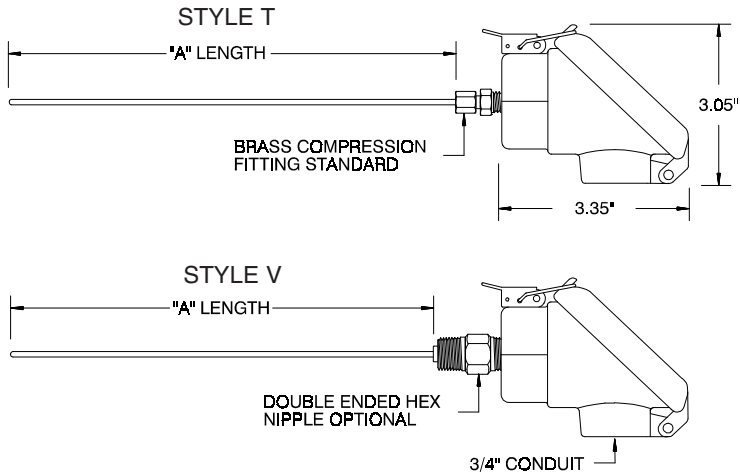

SHEATH TERMINATION

T = Cast Aluminum Weatherproof (200°C)
 V = White Polypropylene Weatherproof (90°C)
 4 = Din "B" Size Aluminum WP (200°C)

ELEMENT TYPE

Resistance @ 0°C	2 Wire	3 Wire	4 Wire
Platinum 100Ω Single	A	B	C
Platinum 100Ω Dual	D	E	N/A
Platinum 500Ω Single	F	G	H
Platinum 1000Ω Single	K	L	M

ACCURACY & TEMPERATURE COEFFICIENT

Accuracy @ 0°C	Din.00385	Jis.00392
Class B (.12%)	G	H
Class A (.06%)	J	K
1/3 RD (.04%)	M	N
1/10TH (.01%)	Q	N/A

TEMPERATURE RANGE

L = -50 to +200° C
 M = -50 to +450° C
 H = -200 to +650° C

SHEATH DIAMETER (Inch)

G = 1/8 (.125)
 I = 3/16 (.188)
 K = 1/4 (.250)
 N = 3/8 (.375)

SPECIAL OPTIONS

G = Grounding Screw
 T = Teflon Encapsulated Sheath

SHEATH MOUNTING FITTING

Select from pages #R-19 & R-20
 None = 00

SHEATH LENGTH ("A" Fractional)

A = None G = 1/4 N = 5/8
 B = 1/16 J = 3/8 Q = 3/4
 C = 1/8 L = 1/2 S = 7/8
 E = 3/16

SHEATH LENGTH ("A")

Whole Inches: Example 06 = 6 inches

SHEATH MATERIAL

W = 316 SS

MISCELLANEOUS CONNECTION HEAD RTD's

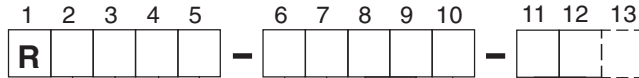
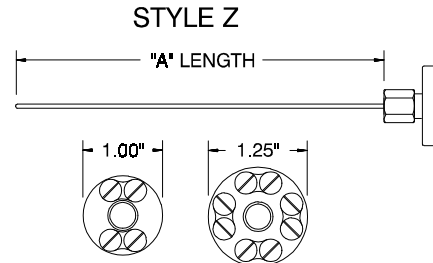
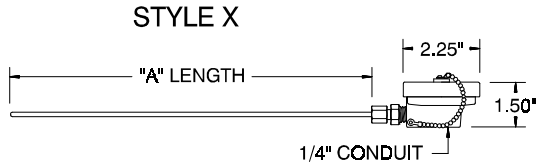
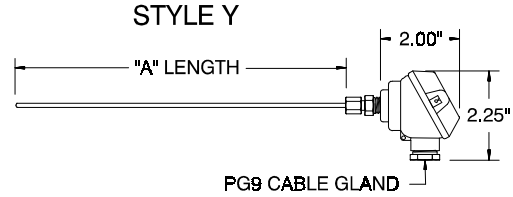
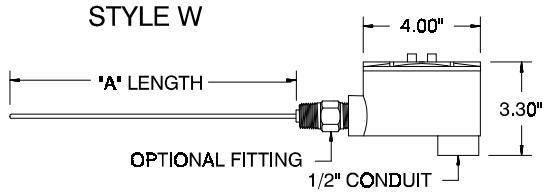

SHEATH TERMINATION

W = Explosion Proof (200°C)*
 X = Miniature Plastic (177°C)
 Y = Miniature Aluminum (200°C)
 Z = Plastic Open Disk (200°C)

ELEMENT TYPE

Resistance @ 0°C	2 Wire	3 Wire	4 Wire
Platinum 100Ω Single	A	B	C
Platinum 100Ω Dual	D	E	N/A
Platinum 500Ω Single	F	G	H
Platinum 1000Ω Single	K	L	M

ACCURACY & TEMPERATURE COEFFICIENT

Accuracy @ 0°C	Din.00385	Jis.00392
Class B (.12%)	G	H
Class A (.06%)	J	K
1/3 RD (.04%)	M	N
1/10TH (.01%)	Q	N/A

TEMPERATURE RANGE

L = -50 to +200° C
 M = -50 to +450° C
 H = -200 to +650° C

SPECIAL OPTIONS

T = Teflon Encapsulated Sheath

SHEATH MOUNTING FITTING

Select from pages #R-19 & R-20
 None = 00

SHEATH LENGTH ("A" Fractional)

A = None G = 1/4 N = 5/8
 B = 1/16 J = 3/8 Q = 3/4
 C = 1/8 L = 1/2 S = 7/8
 E = 3/16

SHEATH LENGTH ("A")

Whole Inches: Example 06 = 6 inches

SHEATH MATERIAL

W = 316 SS

SHEATH DIAMETER (Inch)

G = 1/8 (.125)
 I = 3/16 (.188)
 K = 1/4 (.250)
 N = 3/8 (.375)

* Explosion Proof Head Meets the Following Location Classifications:

- Class I, Groups C & D
- Class II, Groups E, F, & G
- Class III, Div. 1 & 2
- NEMA 7, Groups C & D
- NEMA 9, Groups E, F, & G

SCREW-COVER CONNECTION HEAD RTD's

STYLE 1 & 2



STYLE 3

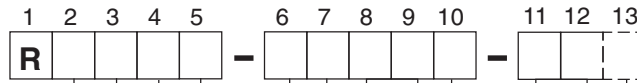
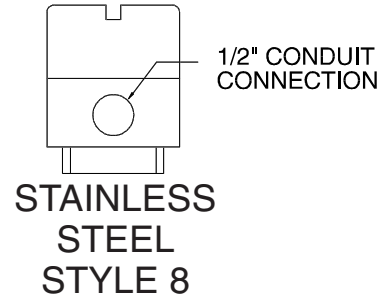
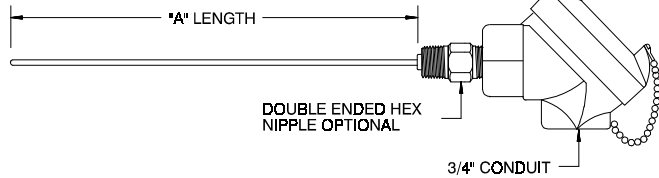

SHEATH TERMINATION

- 1 = Cast Aluminum Weatherproof (200°C)
- 2 = Cast Iron Weatherproof (200°C)
- 3 = Grey Delrin Plastic (135°C)
- 8 = Stainless Steel Weatherproof Connection Head (200°C) (T-304)

ELEMENT TYPE

Resistance @ 0°C	2 Wire	3 Wire	4 Wire
Platinum 100Ω Single	A	B	C
Platinum 100Ω Dual	D	E	N/A
Platinum 500Ω Single	F	G	H
Platinum 1000Ω Single	K	L	M

ACCURACY & TEMPERATURE COEFFICIENT

Accuracy @ 0°C	Din.00385	Jis.00392
Class B (.12%)	G	H
Class A (.06%)	J	K
1/3 RD (.04%)	M	N
1/10TH (.01%)	Q	N/A

TEMPERATURE RANGE

- L = -50 to +200° C
- M = -50 to +450° C
- H = -200 to +650° C

SHEATH DIAMETER (Inch)

- G = 1/8 (.125)
- I = 3/16 (.188)
- K = 1/4 (.250)
- N = 3/8 (.375)

SPECIAL OPTIONS

- G = Ground Screw
- T = Teflon Encapsulated Sheath

SHEATH MOUNTING FITTING

Select from pages #R-19 & R-20
None = 00

SHEATH LENGTH ("A" Fractional)

- A = None G = 1/4 N = 5/8
- B = 1/16 J = 3/8 Q = 3/4
- C = 1/8 L = 1/2 S = 7/8
- E = 3/16

SHEATH LENGTH ("A")

Whole Inches: Example 06 = 6 inches

SHEATH MATERIAL

W = 316 SS

SHEATH MOUNTING FITTINGS

Fixed Brazed or Welded Bushings

Code	Description	NPT	"L"
6A	316 Stainless Steel	1/8	.80
6B	316 Stainless Steel	1/4	.81
6D	316 Stainless Steel	1/2	1.09
6E	316 Stainless Steel	3/4	1.20
7A	Brass	1/8	.80
7B	Brass	1/4	.96
7D	Brass	1/2	1.20

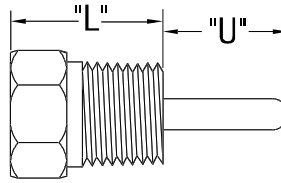

Insert "U" length
Ex. 6D04 = 4" "U" length



COMPRESSION FITTINGS

One-time Adjustable*			Available Sizes and "L" Length				
Code	Description	NPT	1/16"	1/8"	3/16"	1/4"	3/8"
1A	Stainless Steel	1/8	1.27	1.24	1.29	1.29	N/A
1B	Stainless Steel	1/4	1.22	1.40	1.43	1.49	1.57
1D	Stainless Steel	1/2	N/A	1.66	N/A	1.76	1.82
2A	Brass	1/8	1.03	1.02	1.10	1.15	N/A
2B	Brass	1/4	1.22	1.40	1.18	1.24	1.28
2D	Brass	1/2	1.40	1.35	1.25	1.44	1.53

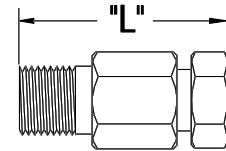

Re-Adjustable*			Available Sizes and "L" Length				
Code	Description	NPT	1/16"	1/8"	3/16"	1/4"	3/8"
3A	Stainless Steel	1/8	1.21	1.21	1.21	N/A	N/A
3B	Stainless Steel	1/4	N/A	1.40	1.43	2.50	2.50
3D	Stainless Steel	1/2	N/A	1.66	N/A	1.76	1.82

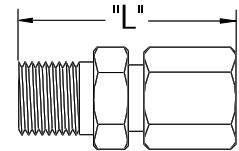

NOTE: All Re-adjustable fittings contain Teflon ferrules standard
Consult Sales for Neoprene or Lava ferrules

Mounting Flanges*

Code	Description
25	Flange w/ Brass Compression, Adjustable
26	Flange w/SS Compression, Adjustable

* NOT AVAILABLE WITH TEFLON COATED SHEATH!

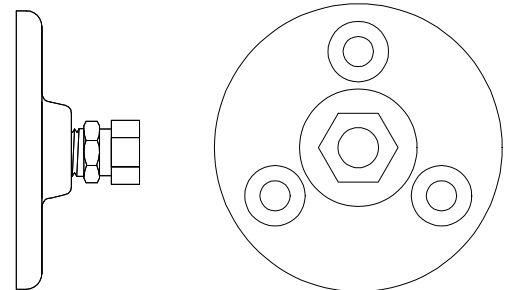

Double Ended Hex Nipples

Code	Description	NPT	"L"	Compatible with Head Order Codes
45	Steel, brazed on	1/2	2.10	T, V, W, 1, 2, 3, 4, 5, 8
46	Stainless Steel (316SS)	1/8	1.01	T, V, X, Y, 1
47	Stainless Steel (316SS)	1/4	2.10	T, V, X, Y, 1
48	Stainless Steel (316SS)	1/2	2.10	T, V, W, 1, 2, 3, 4, 5, 8
55	Steel, spring loaded	1/2	2.10	T, V, 1, 2, 3, 4, 5, 8
56	Stainless Steel, spring loaded	1/2	2.10	T, V, 1, 2, 3, 4, 5, 8
57	Stainless Steel, self contained spring loaded (1/4" sheath only)	1/2	2.50	T, V, W, 1, 2, 3, 4, 5, 8
60	Stainless Steel (316SS)	3/4	2.50	T, V, W, 1, 2, 3, 4, 5, 8
61	Stainless Steel (316SS)	1	2.50	T, V, W, 1, 2, 3, 4, 5, 8

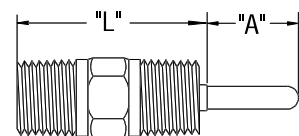

SHEATH MOUNTING FITTINGS and BEND OPTIONS

Bayonet Fittings

Code	Description	Available Sheath Sizes
27	Adjustable Bayonet Fitting	1/8
28	Re-Adjustable Bayonet Fitting	1/8
29*	Fixed Bayonet Fitting	1/8 3/16 1/4

* Insert "U" length
Ex. 2904 = 4" "U" length

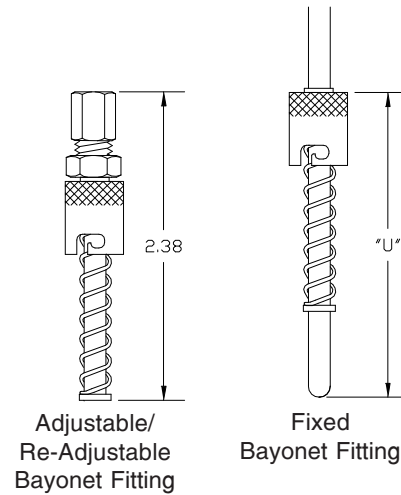

Weld Pads

Code	Description
35	Perpendicular Pad, 316 SS, 1" x 1"
36	Horizontal Pad, 316 SS, 1" x 1"
37	Perpendicular Radius Pad*, 316 SS, 1" x 1"
38	Horizontal Radius Pad*, 316 SS, 1" x 1"

*Specify Radius (Ex. 37(2)=2"R) & consult sales for availability

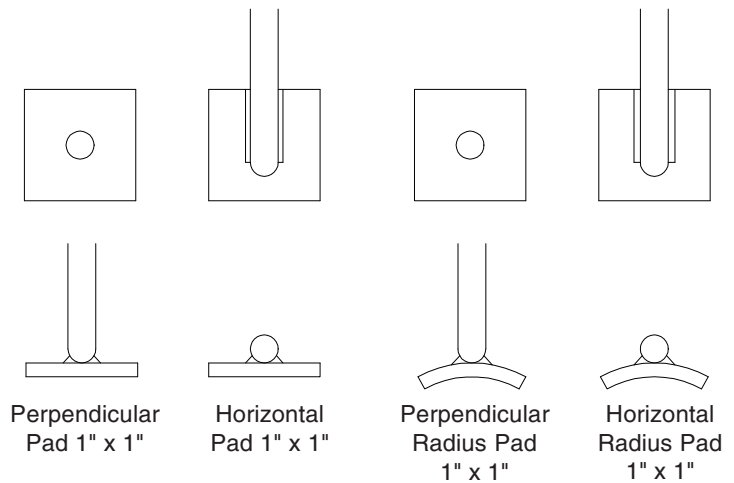

Sheath Bends

Code	Description
A*	90° Bend
B*	45° Bend

* Insert "U" Length
Ex. A04=4" "U" Length

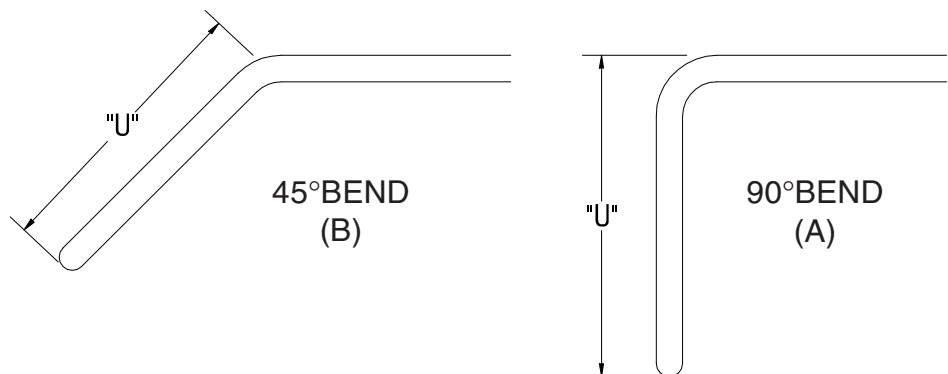

**SINGLE RTD CONFIGURATIONS
& COLOR CODES**

**DUPLEX RTD CONFIGURATIONS
& COLOR CODES**

2-Wire

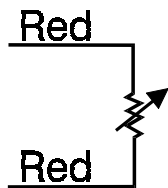

3-Wire

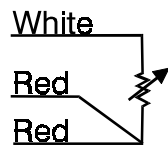

4-Wire

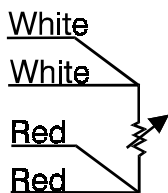

2-Wire

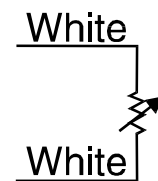
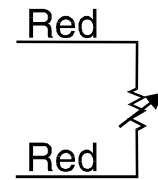

3-Wire

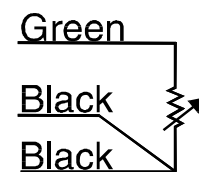
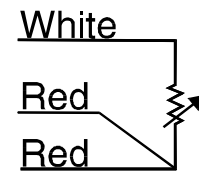

TEMPERATURE/RESISTANCE TABLE

-200°C to 39°C

For 100 Ohm Platinum RTD Sensors (ITS-90 Revision)

°C	α 0.00385	α 0.00392	°C	α 0.00385	α 0.00392	°C	α 0.00385	α 0.00392	°C	α 0.00385	α 0.00392
-200	18.52	17.08	-140	43.88	42.87	-80	68.33	67.76	-20	92.16	92.02
-199	18.95	17.52	-139	44.29	43.29	-79	68.73	68.17	-19	92.55	92.42
-198	19.38	17.96	-138	44.70	43.72	-78	69.13	68.57	-18	92.95	92.82
-197	19.82	18.40	-137	45.12	44.14	-77	69.53	68.98	-17	93.34	93.22
-196	20.25	18.83	-136	45.53	44.56	-76	69.93	69.39	-16	93.73	93.62
-195	20.68	19.27	-135	45.94	44.98	-75	70.33	69.80	-15	94.12	94.02
-194	21.11	19.71	-134	46.36	45.40	-74	70.73	70.21	-14	94.52	94.42
-193	21.54	20.15	-133	46.77	45.82	-73	71.13	70.61	-13	94.91	94.82
-192	21.97	20.58	-132	47.18	46.24	-72	71.53	71.02	-12	95.30	95.22
-191	22.40	21.02	-131	47.59	46.66	-71	71.93	71.43	-11	95.69	95.62
-190	22.83	21.46	-130	48.00	47.07	-70	72.33	71.84	-10	96.09	96.02
-189	23.25	21.89	-129	48.42	47.49	-69	72.73	72.24	-9	96.48	96.41
-188	23.68	22.33	-128	48.83	47.91	-68	73.13	72.65	-8	96.87	96.81
-187	24.11	22.76	-127	49.24	48.33	-67	73.53	73.06	-7	97.26	97.21
-186	24.54	23.20	-126	49.65	48.75	-66	73.93	73.47	-6	97.65	97.61
-185	24.97	23.63	-125	50.06	49.17	-65	74.33	73.87	-5	98.04	98.01
-184	25.39	24.07	-124	50.47	49.58	-64	74.73	74.28	-4	98.44	98.41
-183	25.82	24.50	-123	50.88	50.00	-63	75.13	74.68	-3	98.83	98.81
-182	26.24	24.94	-122	51.29	50.42	-62	75.53	75.09	-2	99.22	99.20
-181	26.67	25.37	-121	51.70	50.84	-61	75.93	75.50	-1	99.61	99.60
-180	27.10	25.80	-120	52.11	51.25	-60	76.33	75.90	0	100.00	100.00
-179	27.52	26.23	-119	52.52	51.67	-59	76.73	76.31	1	100.39	100.40
-178	27.95	26.67	-118	52.93	52.09	-58	77.12	76.71	2	100.78	100.80
-177	28.37	27.10	-117	53.34	52.50	-57	77.52	77.12	3	101.17	101.19
-176	28.80	27.53	-116	53.75	52.92	-56	77.92	77.52	4	101.56	101.59
-175	29.22	27.96	-115	54.15	53.33	-55	78.32	77.93	5	101.95	101.99
-174	29.64	28.39	-114	54.56	53.75	-54	78.72	78.33	6	102.34	102.39
-173	30.07	28.82	-113	54.97	54.16	-53	79.11	78.74	7	102.73	102.78
-172	30.49	29.25	-112	55.38	54.58	-52	79.51	79.14	8	103.12	103.18
-171	30.91	29.68	-111	55.79	54.99	-51	79.91	79.55	9	103.51	103.58
-170	31.33	30.11	-110	56.19	55.41	-50	80.31	79.95	10	103.90	103.97
-169	31.76	30.54	-109	56.60	55.82	-49	80.70	80.36	11	104.29	104.37
-168	32.18	30.97	-108	57.01	56.24	-48	81.10	80.76	12	104.68	104.77
-167	32.60	31.40	-107	57.41	56.65	-47	81.50	81.16	13	105.07	105.16
-166	33.02	31.83	-106	57.82	57.06	-46	81.89	81.57	14	105.46	105.56
-165	33.44	32.26	-105	58.23	57.48	-45	82.29	81.97	15	105.85	105.95
-164	33.86	32.69	-104	58.63	57.89	-44	82.69	82.38	16	106.24	106.35
-163	34.28	33.11	-103	59.04	58.30	-43	83.08	82.78	17	106.63	106.75
-162	34.70	33.54	-102	59.44	58.72	-42	83.48	83.18	18	107.02	107.14
-161	35.12	33.97	-101	59.85	59.13	-41	83.87	83.58	19	107.40	107.54
-160	35.54	34.39	-100	60.26	59.54	-40	84.27	83.99	20	107.79	107.93
-159	35.96	34.82	-99	60.66	59.96	-39	84.67	84.39	21	108.18	108.33
-158	36.38	35.25	-98	61.07	60.37	-38	85.06	84.79	22	108.57	108.72
-157	36.80	35.67	-97	61.47	60.78	-37	85.46	85.20	23	108.96	109.12
-156	37.22	36.10	-96	61.88	61.19	-36	85.85	85.60	24	109.35	109.52
-155	37.64	36.52	-95	62.28	61.60	-35	86.25	86.00	25	109.73	109.91
-154	38.05	36.95	-94	62.68	62.01	-34	86.64	86.40	26	110.12	110.30
-153	38.47	37.37	-93	63.09	62.43	-33	87.04	86.79	27	110.51	110.70
-152	38.89	37.80	-92	63.49	62.84	-32	87.43	87.21	28	110.90	111.09
-151	39.31	38.22	-91	63.90	63.25	-31	87.83	87.61	29	111.29	111.49
-150	39.72	38.65	-90	64.30	63.66	-30	88.22	88.01	30	111.67	111.88
-149	40.14	39.07	-89	64.70	64.07	-29	88.62	88.41	31	112.06	112.28
-148	40.56	39.49	-88	65.11	64.48	-28	89.01	88.81	32	112.45	112.67
-147	40.97	39.92	-87	65.51	64.89	-27	89.40	89.21	33	112.83	113.07
-146	41.39	40.34	-86	65.91	65.30	-26	89.80	89.61	34	113.22	113.46
-145	41.80	40.76	-85	66.31	65.71	-25	90.19	90.02	35	113.61	113.85
-144	42.22	41.19	-84	66.72	66.12	-24	90.59	90.42	36	114.00	114.25
-143	42.63	41.61	-83	67.12	66.53	-23	90.98	90.82	37	114.38	114.64
-142	43.05	42.03	-82	67.52	66.94	-22	91.37	91.22	38	114.77	115.03
-141	43.46	42.45	-81	67.92	67.35	-21	91.77	91.62	39	115.15	115.43

TEMPERATURE/RESISTANCE TABLE

40°C to 279°C

For 100 Ohm Platinum RTD Sensors (ITS-90 Revision)

°C	α 0.00385	α 0.00392	°C	α 0.00385	α 0.00392	°C	α 0.00385	α 0.00392	°C	α 0.00385	α 0.00392
40	115.54	115.82	100	138.51	139.20	160	161.05	162.16	220	183.19	184.69
41	115.93	116.21	101	138.88	139.59	161	161.43	162.54	221	183.55	185.06
42	116.31	116.61	102	139.26	139.97	162	161.80	162.91	222	183.92	185.43
43	116.70	117.00	103	139.64	140.36	163	162.17	163.29	223	184.28	185.81
44	117.08	117.39	104	140.02	140.74	164	162.54	163.67	224	184.65	186.18
45	117.47	117.79	105	140.40	141.13	165	162.91	164.05	225	185.01	186.55
46	117.86	118.18	106	140.78	141.51	166	163.29	164.43	226	185.38	186.92
47	118.24	118.57	107	141.16	141.90	167	163.66	164.81	227	185.74	187.29
48	118.63	118.96	108	141.54	142.29	168	164.03	165.19	228	186.11	187.66
49	119.01	119.35	109	141.91	142.67	169	164.40	165.56	229	186.47	188.03
50	119.40	119.75	110	142.29	143.06	170	164.77	165.94	230	186.84	188.41
51	119.78	120.14	111	142.67	143.44	171	165.14	166.32	231	187.20	188.78
52	120.17	120.53	112	143.05	143.83	172	165.51	166.70	232	187.56	189.15
53	120.55	120.92	113	143.43	144.21	173	165.89	167.07	233	187.93	189.52
54	120.94	121.31	114	143.80	144.59	174	166.26	167.45	234	188.29	189.89
55	121.32	121.71	115	144.18	144.98	175	166.63	167.83	235	188.66	190.26
56	121.71	122.10	116	144.56	145.36	176	167.00	168.21	236	189.02	190.63
57	122.09	122.49	117	144.94	145.75	177	167.37	168.58	237	189.38	191.00
58	122.47	122.88	118	145.31	146.13	178	167.74	168.96	238	189.75	191.37
59	122.86	123.27	119	145.69	146.52	179	168.11	169.34	239	190.11	191.74
60	123.24	123.66	120	146.07	146.90	180	168.48	169.71	240	190.47	192.11
61	123.63	124.05	121	146.44	147.28	181	168.85	170.09	241	190.84	192.48
62	124.01	124.44	122	146.82	147.67	182	169.22	170.47	242	191.20	192.85
63	124.39	124.83	123	147.20	148.05	183	169.59	170.84	243	191.56	193.22
64	124.78	125.22	124	147.58	148.43	184	169.96	171.22	244	191.92	193.59
65	125.16	125.61	125	147.95	148.82	185	170.33	171.60	245	192.29	193.96
66	125.54	126.00	126	148.33	149.20	186	170.70	171.97	246	192.65	194.32
67	125.93	126.39	127	148.70	149.58	187	171.07	172.35	247	193.01	194.69
68	126.31	126.78	128	149.08	149.97	188	171.44	172.73	248	193.37	195.06
69	126.69	127.17	129	149.46	150.35	189	171.80	173.10	249	193.74	195.43
70	127.08	127.56	130	149.83	150.73	190	172.17	173.48	250	194.10	195.80
71	127.46	127.95	131	150.21	151.11	191	172.54	173.85	251	194.46	196.17
72	127.84	128.34	132	150.58	151.50	192	172.91	174.23	252	194.82	196.54
73	128.22	128.73	133	150.96	151.88	193	173.28	174.60	253	195.18	196.90
74	128.61	129.12	134	151.33	152.26	194	173.65	174.98	254	195.55	197.27
75	128.99	129.51	135	151.71	152.64	195	174.02	175.35	255	195.91	197.64
76	129.37	129.90	136	152.08	153.02	196	174.38	175.73	256	196.27	198.01
77	129.75	130.29	137	152.46	153.41	197	174.75	176.10	257	196.63	198.38
78	130.13	130.68	138	152.83	153.79	198	175.12	176.48	258	196.99	198.74
79	130.52	131.07	139	153.21	154.17	199	175.49	176.85	259	197.35	199.11
80	130.90	131.45	140	153.58	154.55	200	175.86	177.23	260	197.71	199.48
81	131.28	131.84	141	153.96	154.93	201	176.22	177.60	261	198.07	199.85
82	131.66	132.23	142	154.33	155.31	202	176.59	177.97	262	198.43	200.21
83	132.04	132.62	143	154.71	155.70	203	176.96	178.35	263	198.79	200.58
84	132.42	133.01	144	155.08	156.08	204	177.33	178.72	264	199.15	200.95
85	132.80	133.39	145	155.46	156.46	205	177.69	179.10	265	199.51	201.31
86	133.18	133.78	146	155.83	156.84	206	178.06	179.47	266	199.87	201.68
87	133.57	134.17	147	156.20	157.22	207	178.43	179.84	267	200.23	202.05
88	133.95	134.56	148	156.58	157.60	208	178.79	180.22	268	200.59	202.41
89	134.33	134.95	149	156.95	157.98	209	179.16	180.59	269	200.95	202.78
90	134.71	135.33	150	157.33	158.36	210	179.53	180.96	270	201.31	203.15
91	135.09	135.72	151	157.70	158.74	211	179.89	181.34	271	201.67	203.51
92	135.47	136.11	152	158.07	159.12	212	180.26	181.71	272	202.03	203.88
93	135.85	136.49	153	158.45	159.50	213	180.63	182.08	273	202.39	204.24
94	136.23	136.88	154	158.82	159.88	214	180.99	182.46	274	202.75	204.61
95	136.61	137.27	155	159.19	160.26	215	181.36	182.83	275	203.11	204.98
96	136.99	137.65	156	159.56	160.64	216	181.72	183.20	276	203.47	205.34
97	137.37	138.04	157	159.94	161.02	217	182.09	183.57	277	203.80	205.82
98	137.75	138.43	158	160.31	161.40	218	182.46	183.95	278	204.19	206.07
99	138.13	138.81	159	160.68	161.78	219	182.82	184.32	279	204.55	206.44



TEMPERATURE/RESISTANCE TABLE

280°C to 519°C

For 100 Ohm Platinum RTD Sensors (ITS-90 Revision)

°C	α 0.00385	α 0.00392	°C	α 0.00385	α 0.00392	°C	α 0.00385	α 0.00392	°C	α 0.00385	α 0.00392
280	204.90	206.80	340	226.21	228.49	400	247.09	249.76	460	267.56	270.60
281	205.26	207.17	341	226.56	228.85	401	247.44	250.11	461	267.90	270.95
282	205.62	207.53	342	226.91	229.21	402	247.78	250.46	462	268.24	271.29
283	205.98	207.90	343	227.26	229.56	403	248.13	250.81	463	268.57	271.63
284	206.34	208.26	344	227.61	229.92	404	248.47	251.16	464	268.91	271.98
285	206.70	208.63	345	227.96	230.28	405	248.81	251.51	465	269.25	272.32
286	207.05	208.99	346	228.31	230.64	406	249.16	251.86	466	269.59	272.66
287	207.41	209.35	347	228.66	230.99	407	249.50	252.21	467	269.92	273.01
288	207.77	209.72	348	229.02	231.35	408	249.85	252.56	468	270.26	273.35
289	208.13	210.08	349	229.37	231.71	409	250.19	252.91	469	270.60	273.69
290	208.48	210.45	350	229.72	232.06	410	250.53	253.26	470	270.93	274.03
291	208.84	210.81	351	230.07	232.42	411	250.88	253.61	471	271.27	274.38
292	209.20	211.17	352	230.42	232.78	412	251.22	253.96	472	271.61	274.72
293	209.56	211.54	353	230.77	233.13	413	251.56	254.31	473	271.94	275.06
294	209.91	211.90	354	231.12	233.49	414	251.91	254.66	474	272.28	275.40
295	210.29	212.26	355	231.47	233.85	415	252.25	255.01	475	272.61	275.75
296	210.63	212.63	356	231.82	234.20	416	252.59	255.36	476	272.95	276.09
297	210.98	212.99	357	232.17	234.56	417	252.93	255.71	477	273.29	276.43
298	211.34	213.35	358	232.52	234.92	418	253.28	256.06	478	273.62	276.77
299	211.70	213.72	359	232.87	235.27	419	253.62	256.40	479	273.96	277.11
300	212.05	214.08	360	233.21	235.63	420	253.96	256.75	480	274.29	277.46
301	212.41	214.44	361	233.56	235.98	421	254.30	257.10	481	274.63	277.80
302	212.76	214.80	362	233.91	236.34	422	254.65	257.45	482	274.96	278.14
303	213.12	215.17	363	234.26	236.69	423	254.99	257.80	483	275.30	278.48
304	213.48	215.53	364	234.61	237.05	424	255.33	258.15	484	275.63	278.82
305	213.83	215.89	365	234.96	237.40	425	255.67	258.49	485	275.97	279.16
306	214.19	216.25	366	235.31	237.76	426	256.01	258.84	486	276.30	279.50
307	214.54	216.61	367	235.66	238.11	427	256.36	259.19	487	276.64	279.84
308	214.90	216.98	368	236.00	238.47	428	256.70	259.54	488	276.97	280.18
309	215.25	217.34	369	236.35	238.82	429	257.04	259.88	489	277.31	280.52
310	215.61	217.70	370	236.70	239.18	430	257.38	260.23	490	277.64	280.87
311	215.96	218.06	371	237.05	239.53	431	257.72	260.58	491	277.98	281.21
312	216.32	218.42	372	237.40	239.89	432	258.06	260.93	492	278.31	281.55
313	216.67	218.78	373	237.75	240.24	433	258.40	261.27	493	278.64	281.89
314	217.03	219.14	374	238.09	240.59	434	258.74	261.62	494	278.98	282.23
315	217.38	219.51	375	238.44	240.95	435	259.08	261.97	495	279.31	282.57
316	217.74	219.87	376	238.79	241.30	436	259.42	262.31	496	279.64	282.91
317	218.09	220.23	377	239.14	241.66	437	259.76	262.66	497	279.98	283.24
318	218.44	220.59	378	239.48	242.01	438	260.10	263.01	498	280.31	283.58
319	218.80	220.95	379	239.83	242.36	439	260.44	263.35	499	280.64	283.92
320	219.15	221.31	380	240.18	242.72	440	260.78	263.70	500	280.98	284.26
321	219.51	221.67	381	240.52	243.07	441	261.12	264.05	501	281.31	284.60
322	219.86	222.03	382	240.87	243.42	442	261.46	264.39	502	281.64	284.94
323	220.21	222.39	383	241.22	243.78	443	261.80	264.74	503	281.98	285.28
324	220.57	222.75	384	241.56	244.13	444	262.14	265.08	504	282.31	285.62
325	220.92	223.11	385	241.91	244.48	445	262.48	265.43	505	282.64	285.96
326	221.27	223.47	386	242.26	244.83	446	262.82	265.78	506	282.97	286.30
327	221.63	223.83	387	242.60	245.19	447	263.16	266.12	507	283.31	286.63
328	221.98	224.19	388	242.95	245.54	448	263.50	266.47	508	283.64	286.97
329	222.33	224.55	389	243.29	245.89	449	263.84	266.81	509	283.97	287.31
330	222.69	224.91	390	243.64	246.24	450	264.18	267.16	510	284.30	287.65
331	223.04	225.26	391	243.99	246.59	451	264.52	267.50	511	284.63	287.99
332	223.39	225.62	392	244.33	246.95	452	264.86	267.85	512	284.97	288.32
333	223.74	225.98	393	244.68	247.30	453	265.20	268.19	513	285.30	288.66
334	224.10	226.34	394	245.02	247.65	454	265.53	268.54	514	285.63	289.00
335	224.45	226.70	395	245.37	248.00	455	265.87	268.88	515	285.96	289.34
336	224.80	227.06	396	245.71	248.35	456	266.21	269.23	516	286.29	289.67
337	225.15	227.42	397	246.06	248.70	457	266.55	269.57	517	286.62	290.01
338	225.50	227.78	398	246.40	249.06	458	266.89	269.91	518	286.95	290.35
339	225.85	228.13	399	246.75	249.41	459	267.22	270.26	519	287.29	290.69

TEMPERATURE/RESISTANCE TABLE

520°C to 661°C

For 100 Ohm Platinum RTD Sensors (ITS-90 Revision)

°C	α 0.00385	α 0.00392	°C	α 0.00385	α 0.00392	°C	α 0.00385	α 0.00392
520	287.62	291.02	580	307.25	311.02	640	326.48	330.60
521	287.95	291.36	581	307.58	311.35	641	326.79	330.92
522	288.28	291.70	582	307.90	311.68	642	327.11	331.24
523	288.61	292.03	583	308.23	312.01	643	327.43	331.57
524	288.94	292.37	584	308.55	312.34	644	327.74	331.89
525	289.27	292.71	585	308.87	312.67	645	328.06	332.21
526	289.60	293.04	586	309.20	313.00	646	328.38	332.53
527	289.93	293.38	587	309.52	313.33	647	328.69	332.85
528	290.26	293.71	588	309.84	313.66	648	329.01	333.18
529	290.59	294.05	589	310.16	313.99	649	329.32	333.50
530	290.92	294.39	590	310.49	314.31	650	329.64	333.82
531	291.25	294.72	591	310.81	314.64	651	329.96	334.14
532	291.58	295.06	592	311.13	314.97	652	330.27	334.46
533	291.91	295.39	593	311.45	315.30	653	330.59	334.78
534	292.24	295.73	594	311.78	315.63	654	330.90	335.11
535	292.56	296.06	595	312.10	315.96	655	331.22	335.43
536	292.89	296.40	596	312.42	316.28	656	331.53	335.75
537	293.22	296.73	597	312.74	316.61	657	331.85	336.07
538	293.55	297.07	598	313.06	316.94	658	332.16	336.39
539	293.88	297.40	599	313.39	317.27	659	332.48	336.71
540	294.21	297.74	600	313.71	317.59	660	332.79	337.03
541	294.54	298.07	601	314.03	317.92	661	333.11	337.35
542	294.87	298.40	602	314.35	318.25			
543	295.19	298.74	603	314.67	318.58			
544	295.52	299.07	604	314.99	318.90			
545	295.85	299.41	605	315.31	319.23			
546	296.18	299.74	606	315.64	319.56			
547	296.50	300.07	607	315.96	319.88			
548	296.83	300.41	608	316.28	320.21			
549	297.16	300.74	609	316.60	320.54			
550	297.49	301.08	610	316.92	320.86			
551	297.81	301.41	611	317.24	321.19			
552	298.14	301.74	612	317.56	321.51			
553	298.47	302.07	613	317.88	321.84			
554	298.80	302.41	614	318.20	322.17			
555	299.12	302.74	615	318.52	322.49			
556	299.45	303.07	616	318.84	322.82			
557	299.78	303.41	617	319.16	323.14			
558	300.10	303.74	618	319.48	323.47			
559	300.43	304.07	619	319.80	323.79			
560	300.75	304.40	620	320.12	324.12			
561	301.08	304.73	621	320.43	324.44			
562	301.41	305.07	622	320.75	324.77			
563	301.73	305.40	623	321.07	325.09			
564	302.06	305.73	624	321.39	325.42			
565	302.38	306.06	625	321.71	325.74			
566	302.71	306.39	626	322.03	326.07			
567	303.03	306.72	627	322.35	326.39			
568	303.36	307.06	628	322.67	326.72			
569	303.69	307.39	629	322.98	327.04			
570	304.01	307.72	630	323.30	327.36			
571	304.34	308.05	631	323.62	327.69			
572	304.66	308.38	632	323.94	328.01			
573	304.98	308.71	633	324.26	328.34			
574	305.31	309.04	634	324.57	328.66			
575	305.63	309.37	635	324.89	328.98			
576	305.96	309.70	636	325.21	329.31			
577	306.28	310.03	637	325.53	329.63			
578	306.61	310.36	638	325.84	329.95			
579	306.93	310.69	639	326.16	330.28			