

PANEL HEATERS

**UNIFORM IR COVERAGE FLEXIBLE SIZING OPTIONAL
AIRFLOW UP TO 60 WATTS/SQ. IN. EXTREMELY
DURABLE NOTABLY LONG LIFE ENERGY EFFICIENT
MANY MODELS OFFERED**

**ELECTRIC INFRARED HEATERS FROM SOLAR
PRODUCTS, INC. THE INFRARED HEATER COMPANY
FOR MORE THAN 60 YEARS**

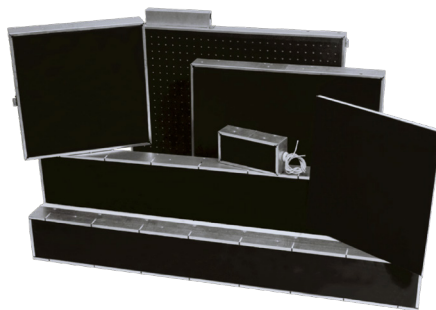
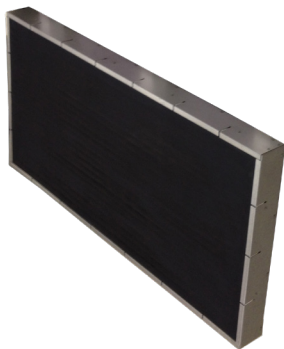

WHY SOLAR PRODUCTS PANEL HEATERS?

Thousands of existing designs to choose from is one good reason! Solar Products has been manufacturing custom infrared heaters for over 60 years. That experience ensures that you get the right heater for your application, the first time. With so many panel heater options available, we can provide one that works for your existing application and/or provide a new design that maximizes your process.

SOLAR PRODUCTS OFFERS:

- Custom designs that match your requirements
- Heater face options include: quartz composite, glass, metal, and opaque quartz
- Panel type construction for easy installation
- Flag, stud, or wire lead terminals
- Many thermowell and thermocouple options
- Coiled heating elements
- Insulation options to meet or exceed your design specifications
- Optional forced air flow through the face or through a duct extension allows for combination heating, moisture removal, or fast cool down
- Power watt densities up to 60 watts/sq in (93 kw/m²)
- Any voltage and/or phase, including dual voltage and/or dual phase
- Flexible sizing to match your specific application
- Multiple zones per heater available
- Compensated edge heating
- Complex frame shapes, such as a parallelogram, can be achieved
- Many mounting options
- Heater thickness can range from 1.25" (32mm) up to 6" (152mm) with 3" (76mm) being the typical thickness
- High radiant efficiency designs that maintain over time - means no need for external reflectors
- Proven stainless steel terminal to heating element connection
- Quality construction
- Uniform IR coverage
- Patented manufacturing process

With so many panel heater options, how do you choose which one is right for your application? The many options and related advantages will be reviewed throughout this brochure.

SOLAR PRODUCTS HEATERS ARE USED IN THE FOLLOWING INDUSTRIES:

- Thermoforming
- Semiconductor
- Adhesives
- Glass Tempering and Bending
- Food
- Electronics
- Screen Printing
- Paint and Powder
- Paper, Textile, Wood
- Curing, Drying, or Heating

JUST TO NAME A FEW !

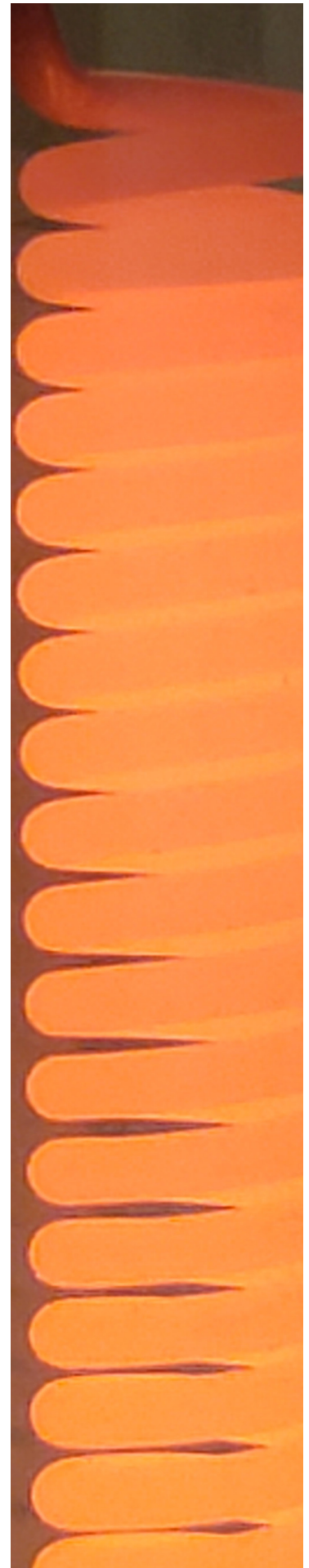

QUARTZ COMPOSITE is the standard face on the F-SERIES panel heaters, our best selling heater due to its flexibility, durability, efficiency, and price. It consists of a patented process, using high temperature material, which bonds quartz fabric with a ceramic fiber coil support using a special cement. The end result is a unique, highly durable, quartz composite face heater.

The F-Series has a tremendous amount of flexibility. The heater can be manufactured in rectangular (most common), square, round, or even C-shaped. The heat can be aimed in a single direction, which is most common, or can be aimed in dual directions. Special designs help to avoid cold spots across wide web applications. The maximum watt density of 25 wsi (39 kw/m²) provides sufficient power for most applications. Again, making the F-Series the logical heater choice. Most infrared heaters on the market today require the use of an external reflector, which results in a dramatic loss of radiant efficiency over time. The proven design of the F-Series heater requires no external reflector and therefore results in consistently high radiant efficiency over time. Match all of these benefits along with long life and competitive pricing and a great value is guaranteed.

The F-Series is used in virtually all process heating applications. The only areas of concern would be in an

application where material could damage the heater face or in a vacuum application. Otherwise, this is the perfect heater for most infrared heating, drying, or curing applications.

F-SERIES SPECIFICATIONS

Dimensionally, the heater can be as wide as 30" (762mm) and as long as 84" (2133 mm), though not this wide and long in the same heater. An 84" (2133mm) long heater is more commonly 12" (305mm) wide. This heater is very flexible in sizing and watt density options. It has a maximum watt density of 25 wsi (39 kw/m²). Durability is defined by a typical life expectancy of 25,000 hours. The heater has a high radiant efficiency of 78.5%. Because the heater design does not depend on an external reflector, the heater maintains that efficiency over time. The F-Series heat transfer rate at 25 wsi (39 kw/m²) is 2.4 Btu/sq. ft./sec. delivered to the product. The F-Series heat transfer rate at 12.5 wsi (19.4 kw/m²) is 1.15 Btu/sq. ft./sec. delivered to the product.



The heat transfer rate is the radiant energy delivered to the product, not the energy absorbed by the product. Energy can be reflected, transmitted, or absorbed. The absorbed energy ultimately determines the rate of useful heat transfer.

F-SERIES PANEL HEATER

MODELS: FB & FBA

The F-SERIES line of IR panel heaters have a very durable emitter surface constructed using a patented manufacturing process. The model FB has a solid flat uniform surface. The FBA heater has air holes drilled throughout the face of the heater. The insulation is removed to allow for an air delivery plenum in the FBA heater.

- 1 High temperature quartz cloth
- 2 High temperature black coating
- 3 High temperature cement bond
- 4 Refractory board to hold resistance wire
- 5 Precision resistance wire
- 6 Quartz thermowell tube (optional)
- 7 Heavy gauge aluminized steel frame
- 8 Blanket insulation
- 9 Ceramic bushings to insulate terminals
- 10 Stainless steel terminals heating element connection

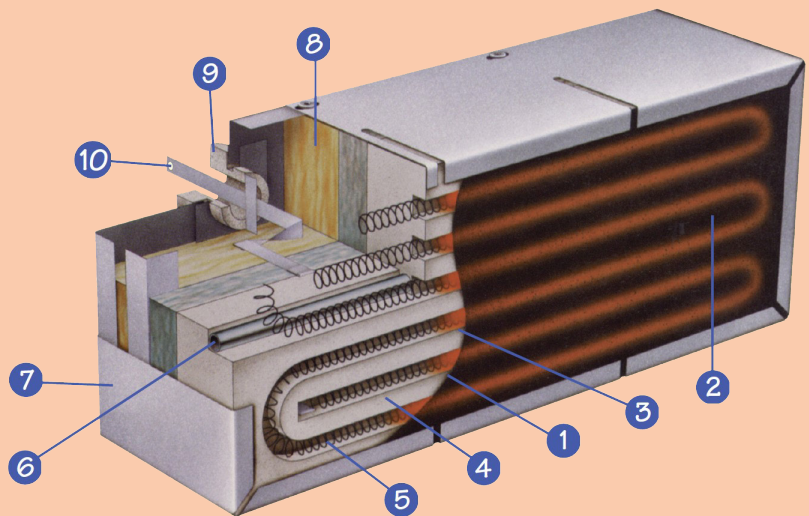

The radiant efficiency is defined as the ratio between the power radiated to the product and the total power consumed. The heater radiant efficiency has been tested by Hydro Quebec LTEE - Laboratoire des Technologies Electrochimiques. LTEE is located in Shawinigan, Quebec-Canada. LTEE is a certified testing facility for determining transient behavior characteristics, spectral emission curves, radiant heat flux distribution maps, and infrared heater radiant efficiency.

Warm-up curves are measured from heaters running face down in open air. The thermocouple is located in the standard location in a thermowell located behind the coil. Curves will change with environment and thermocouple location.

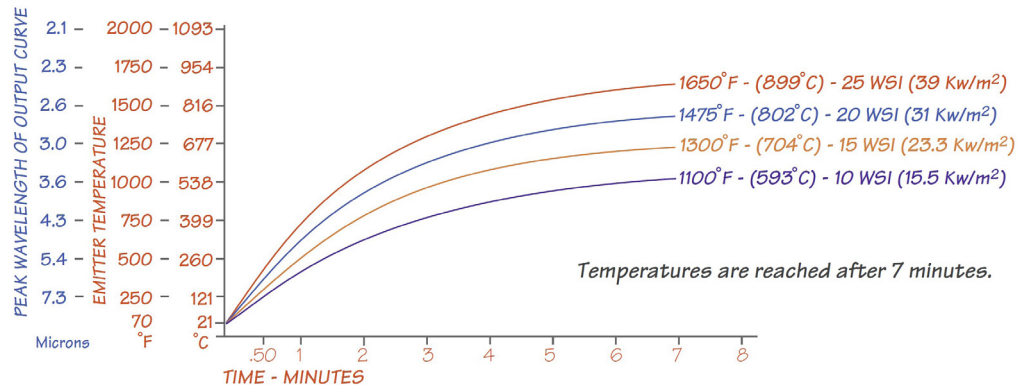

THE FBA MODEL has holes drilled in the heater face to allow for forced airflow through the heater. The purpose of the airflow is to either protect sensitive material or components from being damaged from the IR heating, improve drying by gently sweeping the moisture away, or to provide combination infrared/convection heating. This heater is an extension of the F-Series heater. The heater is manufactured with either 1/8" (3.2mm) or 1/4" (6.4mm) holes that are most often 1" (25.4mm) on center. There is no internal insulation in this heater which allows for a 2"-5" (50.8-127mm) typical plenum area in the heater cavity. The heater will commonly have a back-mounted 3" (76.2mm) hole for airflow. The hole size can match your specifications. Smaller heaters will have one hole, while larger heaters could have multiple holes. The airflow can also be directed through the side or end of the heater casing in some applications. Individual high temperature fans can be attached directly to these holes or a centrifugal fan can be used with ductwork to supply the air to multiple heaters. The airflow commonly ranges from 20 - 50 cfm/sq. ft. Applications include removing moisture, secondary stage powder coating oven, screen printing, and electronics, just to name a few.

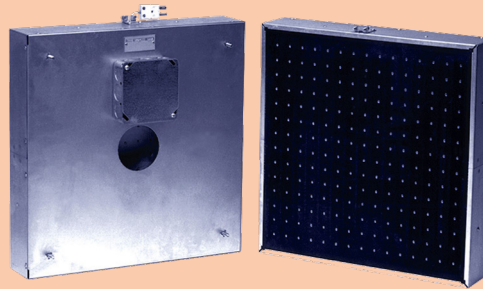

FBA-SERIES SPECIFICATIONS

Dimensionally the heater can be as wide as 24" (610mm) and as long as 72" (1829mm), though not this wide and long in the same heater. A 72" (1829mm) long heater is more commonly 12" (305mm) wide. The heater has a maximum watt density of 25 wsi (39 kw/m²). Durability is defined by a typical life expectancy of 25,000 hours. The heater has a high radiant efficiency of 78.5%. Because the heater design does not depend on an external reflector, the heater maintains that efficiency over time.

GLASS is the standard face on the G-SERIES panel heaters. There are two versions of this heater. The GB heater makes use of a high temperature (1202°F/ 650°C continuous operating temperature) black glass. The remaining construction is similar to the F-Series heater with the exception of the glass replacing the quartz fabric as the face material.

The glass face heater is used when there is concern of material falling onto the face of the heater. The glass face allows for easy clean up, without damage to the heater or heating element. Common applications are the bottom oven in a thermoforming machine or the bottom heater in a wave solder oven.

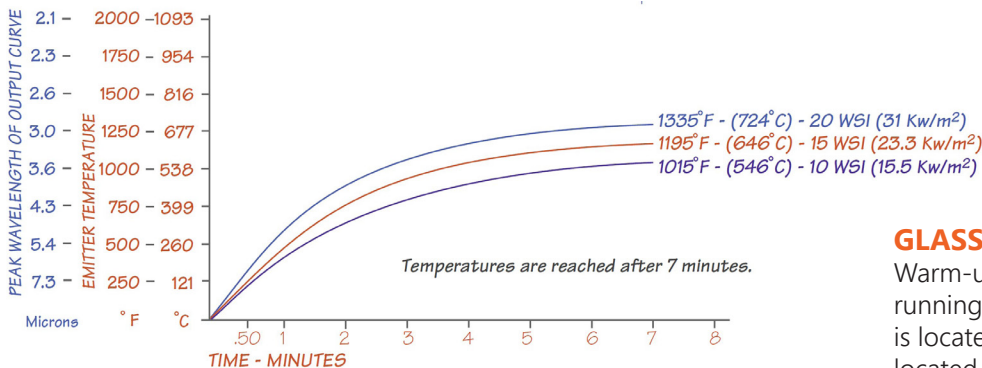

G-SERIES SPECIFICATIONS

Dimensionally, the heater can be as wide as 24" (610mm) and as long as 36" (914 mm), though not this wide and long in the same heater. A 36" (914mm) long heater is more commonly 12" (305mm) wide. This heater has a maximum watt density of 20 wsi (31 kw/m²). Durability is defined by a typical life expectancy of 25,000 hours. The heater has a high radiant efficiency of 77.5%. Because the heater design does not depend on an external reflector, the heater maintains that efficiency over time. The G-Series heat transfer rate at 20 wsi (31 kw/m²) is 1.9 Btu/sq. ft./sec. delivered to the product.

GLASSFACE WARM - UPCURVE

Warm-up curves are measured from heaters running face down in open air. The thermocouple is located in the standard location in a thermowell located behind the coil. Curves will change with environment and thermocouple location.

G-SERIES, M-SERIES PANEL HEATERS

The G-SERIES and M-SERIES line of IR panel heaters uses high temperature material as the radiant surface. All heaters provide uniform coverage with the convenience of a cleanable surface.

FEATURES:

- 1 Glass or metal emitter surface material
- 2 Ceramic standoffs; keep electrically conductive material separated from resistance wire.
- 3 High temperature cement bond
- 4 Refractory board to hold resistance wire
- 5 Precision resistance wire
- 6 Heavy gauge aluminized steel frame
- 7 Blanket insulation layer
- 8 Ceramic bushings to insulate terminals
- 9 Stainless steel terminals
- 10 Quartz thermowell tube (optional)

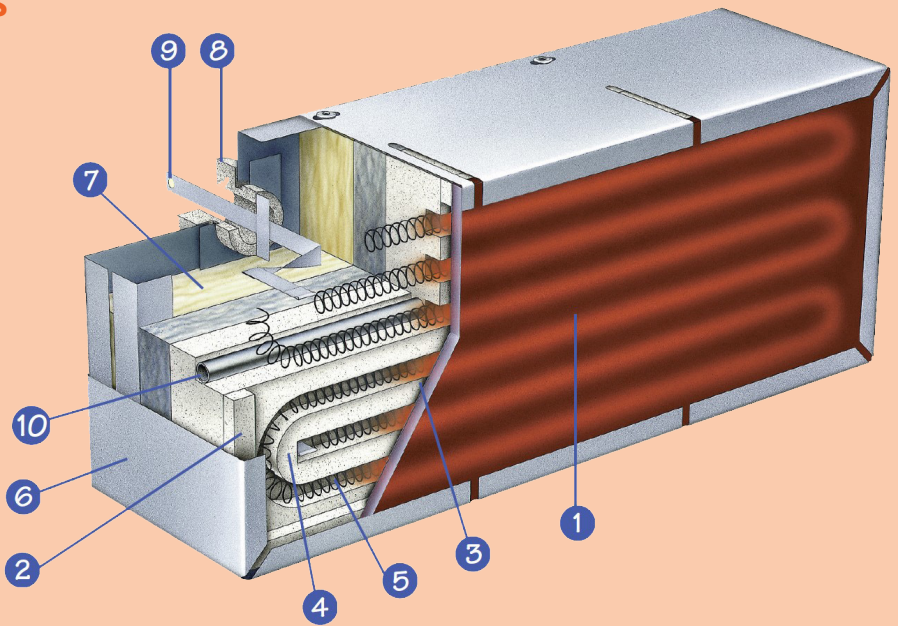

METAL is the standard face on the M-SERIES panel heaters. The face can be either hard-coated aluminum or porcelainized steel. The remaining construction is exactly the same as the G-Series heaters. The heater face can be provided with air holes for forced airflow as in the FBA construction. The metal face is used when there is concern of material falling onto the heater face. The metal face is more durable than the glass face. The flip side is that the radiant efficiency is slightly lower with a metal face. A glass face heater allows a portion of the IR energy to transmit through the glass and a segment of the IR energy is absorbed by the glass and re-radiated. A metal face heater absorbs all of the energy and re-radiates that energy to the process. In some cases, applications are extremely grueling and require a slightly different design. This design makes use of the hard-coated aluminum face being constructed in a cap (pan) style. This design ensures that material cannot get inside the heater.



M-SERIES SPECIFICATIONS

Dimensionally, the heater can be as wide as 24" (610 mm) and as long as 48" (1219 mm), though not this wide and long in the same heater. A 48" (1219 mm) long heater is more commonly 12" (305 mm) wide. This heater has a maximum watt density of 10-15 wsi (15.5 - 23 kw/m²), depending on which metal face is used. Durability is defined by a typical life expectancy of 25,000 hours. The heater has a radiant efficiency of 64%. Because the heater design does not depend on an external reflector, the heater maintains efficiency over time. The M-Series heat transfer rate at 10 wsi (15.5 kw/m²) is 0.786 Btu/sq. ft./sec. delivered to the product.

V-SERIES is a revolutionary design for industrial heating applications. The V series provides high power, tight process control and fast heat up/cool down. V series heaters offer power densities and response times that rival those of short wavelength heaters except they come in a very durable construction and have a medium wavelength output which is readily absorbed by most products.



V-SERIES SPECIFICATIONS

Dimensionally, the heater is highly customized and all concepts should be discussed prior to ordering. This heater has a maximum watt density of 100 wsi with element temperatures up to 2100 °F (2 micron peak wavelength). Durability is defined by a typical life expectancy of 12,000 + hours.

OPAQUE QUARTZ is the standard face on the Q-SERIES panel heaters. For over 60 years, Solar Products has been an original manufacturer of fused silica (opaque quartz). The properties of quartz make for a very efficient radiator of infrared energy. Our expertise with infrared heaters, combined with our ability to fuse quartz allows Solar Products to be the only company in the world to manufacture this unique heater. The back of each fused quartz face is precision machined to hold the resistance coil. With the coils resting in the grooves, the coils are surrounded by three walls of quartz, thereby maximizing the energy output of the heater. A reflective insulating fiber board is added behind the heating element to direct the IR energy forward through the quartz face. Double layer insulation is installed behind the insulating board to decrease back heat loss. Aluminized steel casings and welded stainless steel terminations are standard throughout. Orientation of the Q-Series heater must be controlled. The heating elements are not cemented in place. Therefore, it is important to assure that the heating elements are not placed in a vertical orientation. This will result in slumping of the coils and a greatly reduced life expectancy. The QH model uses a very high purity 99.998% quartz, which is often used for semiconductor applications. This is due to the high purity level of quartz, the temperature uniformity, and the ability to create unique shapes. The Q-Series heater is additionally used in many applications that require high intensity heat, such as high speed drying or curing lines.

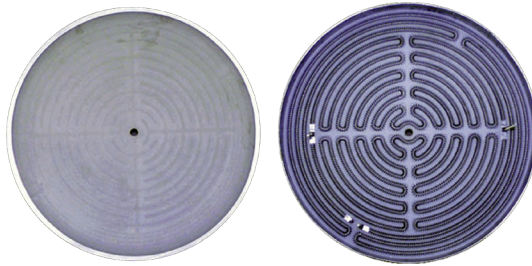
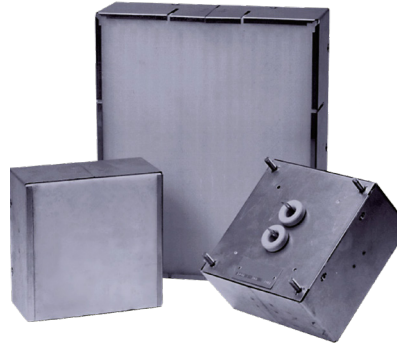

Q-SERIES SPECIFICATIONS

Dimensionally, the heater can be as wide as 12" (305mm) and as long as 12" (305mm) or smaller. The QH model has a maximum watt density of 60 wsi (93 kw/m²). Durability is defined by a typical life expectancy of 25,000 hours. The heater has a high radiant efficiency of 82%. Because the heater design does not depend on an external reflector, the heater maintains efficiency over time. The Q-Series heat transfer rate at 60 wsi (93 kw/m²) is 6.04 Btu/sq. ft./sec. delivered to the product.

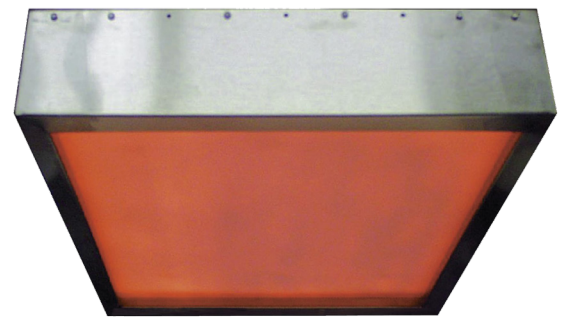

Q-SERIES

MODELS: QH

The Q-SERIES line of IR panel heaters offer the highest power density output available in an IR panel heater. High purity, fused, translucent quartz is used as the emitter face.

FEATURES:

- 1 Grooved, fused, translucent quartz emitter surface plate
- 2 Precision wound resistance wire
- 3 Heavy gauge aluminized steel frame
- 4 High temperature, rigid refractory
- 5 Support angle; secures quartz plate in frame
- 6 Refractory blanket insulation layer
- 7 Bulk insulation to minimize back heat loss
- 8 Ceramic bushings to insulate terminals
- 9 Stainless steel terminals: welded for longer life
- 10 Quartz thermowell tube (optional)

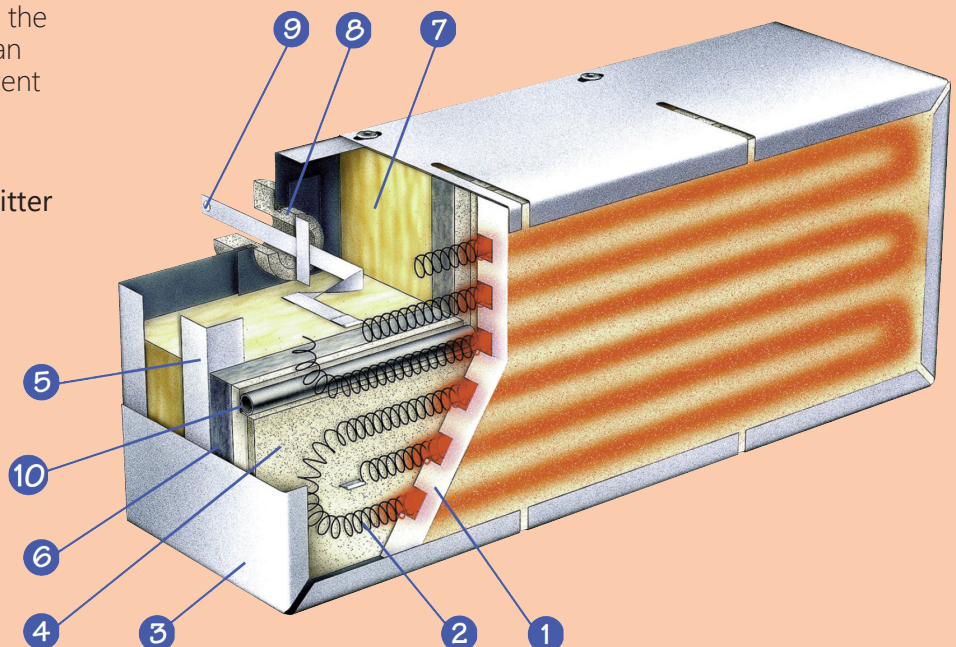

Warm-up curves are measured from heaters running face down in open air. The thermocouple is located in the standard location in a thermowell located behind the coil. Curves will change with environment and thermocouple location.

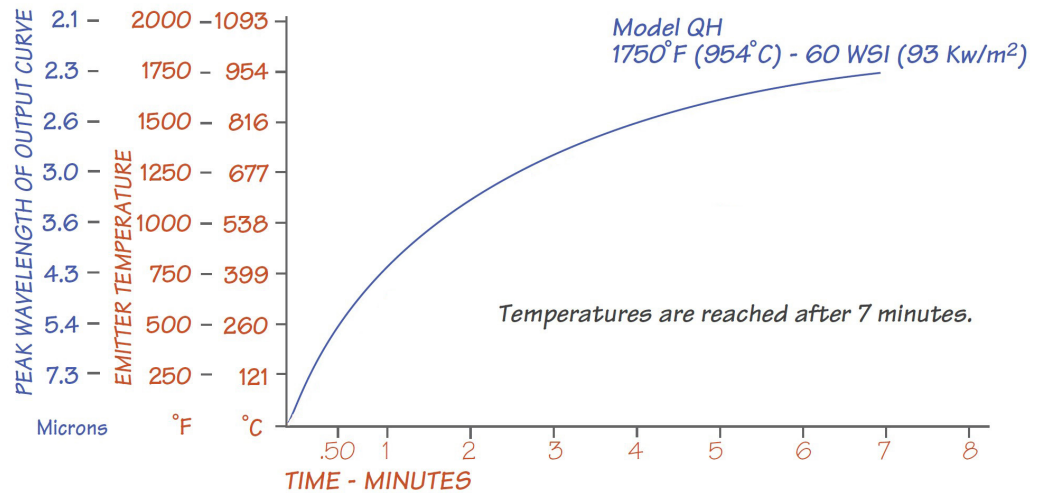

CONSTRUCTION OPTIONS

HOUSING OPTIONS

The heater case or housing can be aluminized steel, stainless steel, or the heater can be supplied, in some instances, without a case. Aluminized steel is by far the most common case material. Aluminized steel can reach very high temperatures, namely 1200°F (649°C), without flaking, discoloring, or degrading. This assures a heater case that will outlive the heater itself. The housing is typically riveted together. The rivets, along with slots in the heater case, allow for controlled expansion and contraction during heat up and cool down. Some applications require the slots to be removed, which can be achieved for many designs. Stainless steel cases are used in both food and semiconductor applications. The 304 grade of stainless is most common. Stainless steel offers enhanced cleanliness and a very polished appearance. It is important to note that 304 grade stainless steel will discolor at a lower temperature than will aluminized steel. For this reason, 310 stainless steel is available for extremely high temperature applications. In most cases, the stainless case is riveted together as with aluminized steel. There are some applications where the stainless case is welded and polished for superior cleanliness and cosmetic appeal. Those housings are most often supplied without expansion slots as well. This construction is most often associated with either a glass, or quartz face heater.

The last option is no case at all. We refer to this option as a board only heater. This heater is most often the F-Series heater without the housing, insulation, or pre-constructed panel design. Customers that have in-house sheet metal capability will sometimes choose to buy the heating element, fiber board, quartz fabric, and cement as a completed assembly. The remaining components of the panel fall under the customer's responsibility. This approach shifts much of the heater construction onto the customer and additionally shifts many of the warranty issues.

STANDARD DIMENSIONS

Width (mm)	Length (mm)	F Series	FBA Series	G Series	M Series	Q Series
6" (152.4)	12" (304.8) • 18" (457.4) • 24" (609.6) • 30" (762) • 36" (914.4)	X	X	X	X	
6" (152.4)	42" (1066.8) • 48" (1219.2) • 54" (1371.6) • 60" (1524)	X	X	X		
10" (254)	4" (101.6) • 6" (152.4) • 8" (203.2) • 10" (254)					X
12" (304.8)	6" (152.4) • 10" (254) • 12" (304.8)					X
12" (304.8)	12" (304.8) • 18" (457.4) • 24" (609.6) • 30" (762) • 36" (914.4)	X	X	X	X	
12" (304.8)	42" (1066.8) • 48" (1219.2) • 54" (1371.6) • 60" (1524)	X	X		42" or 48"	
12" (304.8)	72" (1829) • 84" (2133.6)	X	72" only			
16" (406.4)	16" (406.4) • 24" (609.6)	X	X	X	X	
18" (457.2)	18" (457.2)	X	X	X	X	
24" (609.6)	24" (609.6)	X	X			

Solar Products specializes in manufacturing custom heaters that match a specific application.

Listed above are standard heater dimensions. Call us today to review your actual heater requirements.

VOLTAGE, PHASE, & OTHER OPTIONS

VOLTAGE

Solar Products is a custom manufacturer of heaters and can therefore provide the heaters designed for all commercially or industrially supplied voltages - 120, 208, 220, 230, 240, 277, 380, 415, 460, 480, 575, 600 or whatever voltage is required. In many cases, heaters are provided in dual voltage. This helps to reduce the heater stocking requirements. Dual voltage heaters must always be a derivative of two, namely 120/240 or 240/480. There are some cases where three voltages can be available. This is only true for heaters with a minimum of 6 heating elements and 7 terminals. This wiring arrangement can be configured for 3 voltages and dual phase. Consult Solar Products for your specific heater requirements.

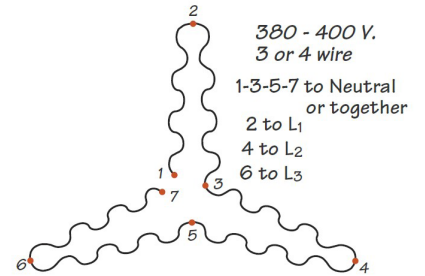
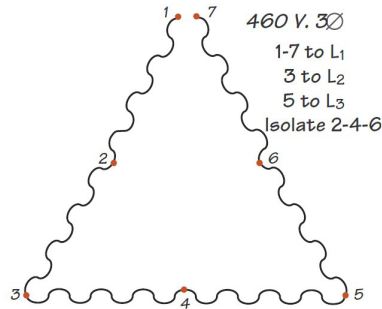
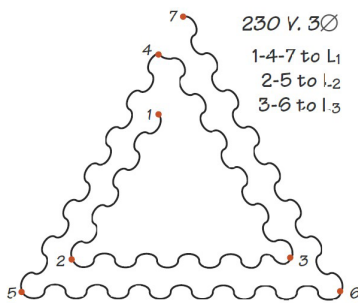

PHASE

Solar Products can manufacture the heaters for single, three, or in some instances dual phase. Consult Solar Products for your specific heater requirements.

FREQUENCY

Fixed resistance heaters operate independent of frequency with no change in design. Therefore, frequency is not an issue.

FIXED RESISTANCE

The heaters are all fixed resistance. This means that the wattage achieved is a direct result of voltage applied. $W = V^2/R$. If the voltage varies, the heater wattage will vary by a squared relationship of the voltage, unless properly controlled. Proper control makes use of a temperature controller or a power controller that can maintain a constant power output. Solar Products heaters are designed for hot resistance ensuring true power output.

ZONING

The heaters can be separated into multiple zones in one given panel. An example would be the use of (3) 12" x 24" (305mm x 610mm) zones in a 12" x 72" (305mm x 1829mm) heater or (2) 6" x 48" (152.4mm x 1219mm) zones in a 12" x 48" (309mm x 1219mm) heater. The heater would be divided up in this fashion to accommodate different widths in a web application. Sometimes a heater is divided up into an outer zone and an inner zone. A last option would be to apply multiple oddly shaped zoned to match a specific heating profile.

EDGE COMPENSATION

Another option that is applied to infrared heaters is the use of edge compensation. This approach places a slightly higher watt density along one long edge of a 24" x 36" (610mm x 915mm) heater, as an example. To help compensate for heat loss along that open edge, a higher watt density is constructed into the heater design for reduced edge heat loss.

DEPTH

There is no standard thickness for Solar Products heaters. The most common depth is 3" (76mm). Heaters are manufactured as thin as 1.25" (32mm) and as thick as 6" (152mm). The heater depth is most often determined by available space and/or a required back temperature.

WAVE LENGTH

The wavelength output from Solar Products heaters ranges from 2.3 microns to 6 microns. Wavelength is inversely proportional to temperature. That is to say, as temperature goes up, wavelength goes down. All heaters output energy over a range of wavelengths as depicted in the Heater Output Curves. Heater A displays a typical short wave heater. Heater B displays a typical medium wave heater. Heater C displays a typical long wave heater. All of the curves have one common characteristic. If a line were drawn vertically through the peak of the curve, then the area left of the line represents 25% of the total energy output being shorter than the peak wavelength and the area to the right of the curve represents 75% of the energy at a longer wavelength than the peak. Solar Products panel heaters output the majority of the energy in the medium wavelengths when operating at higher watt densities and higher temperatures. When the temperature is reduced below 900°F (482°C), the majority of the energy falls into the long wavelengths. Medium wavelength ranges from 2-4 microns. Long wavelength ranges from 4-1000 microns. The effective process heating range for long wavelength IR would be from 4-6 microns. Six microns relates to a temperature of 500°F (260°C). An infrared heater with a surface temperature below 500°F (260°C) has little use in industrial process heating applications.

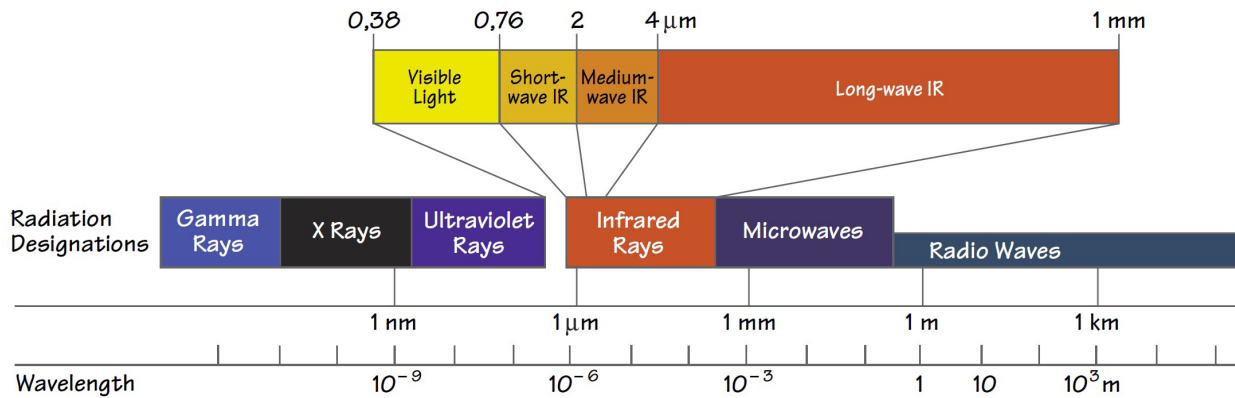
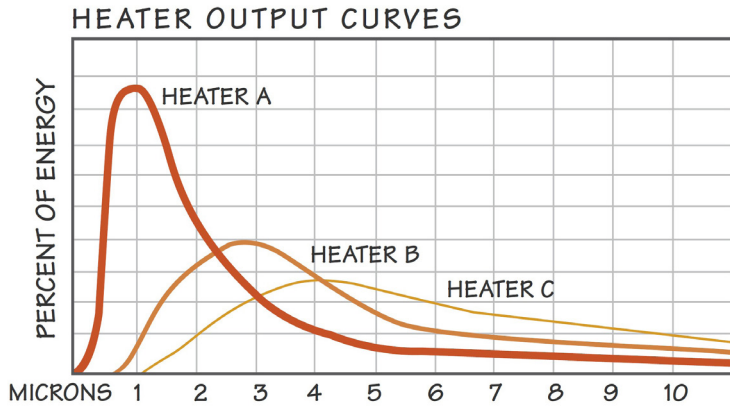

COMPLETE HEATER LAYOUT

The heater below displays examples of the many options available and the typical positioning of the components. All options, however, would not be used simultaneously on a production heater.

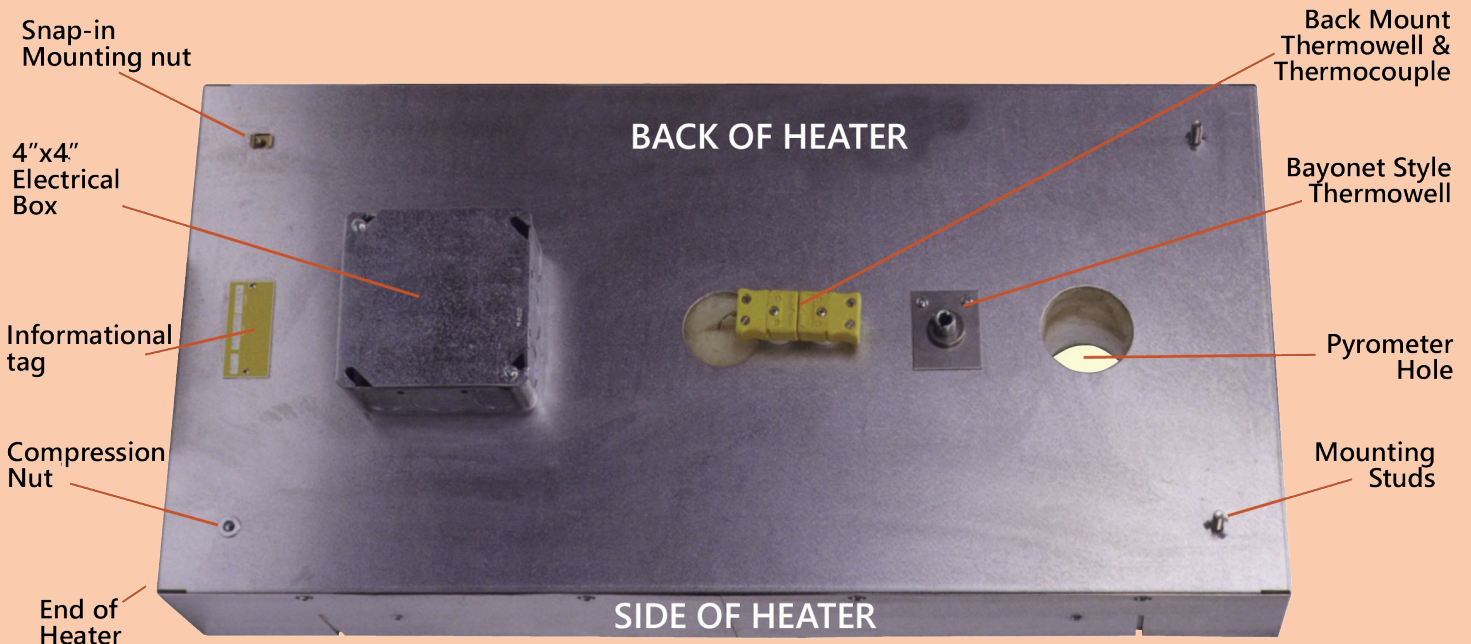

ELECTRICAL TERMINATION OPTIONS

FLAG TYPE

The flag type terminal consists of a flat piece of stainless steel that is .350" (8.9mm) wide x .032" (0.81mm) thick with a .187" (4.75mm) hole near the end. This is the Solar Products preferred termination due to the excellent electrical contact that is achieved with this type of connection. All of the electrical terminal options are typically housed within a 2" x 4" (51mm x 101.6mm) or 4" x 4" (101.6mm x 101.6mm) electrical box.

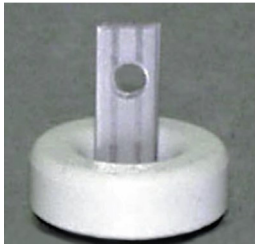

STUD TYPE

The stud type terminal consists of a threaded stud that exits the heater for electrical connection. Many lengths and size studs are available. The disadvantage of a stud type terminal is the current limit of the stud. Electrical current is only carried on the threads of the stud.

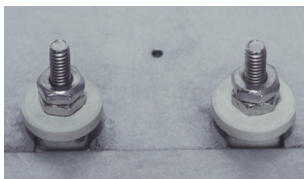

STUD TYPE 2

Another version of this connection is the ceramic block flag type terminal. This design makes use of the flag type terminal exiting the heater that is then bent over a ceramic mounting block with a vertically mounted stud. This approach uses the stud as a means of easy connection, but not as a current carrying device. Therefore, higher current can be carried through the electrical connection. This type of connection is not available on all heaters. Consult Solar Products for your specific heater requirements.

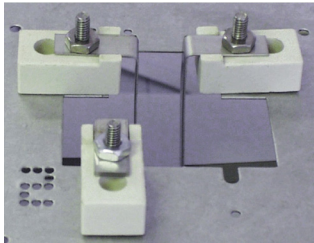

WIRE LEADS

The wire leads option is a fourth termination option available on Solar Products heaters. This option is only available on heaters with the watt density lower than 10 wsi (15.5 kw/m²). A high temperature wire is resistance welded to an intermediate piece of stainless steel which is in turn resistance welded to the heating element. The wire leads can be any required length.

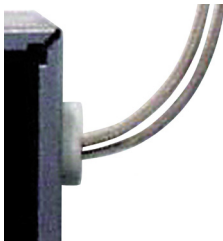

STUDS

The mounting weld studs are commonly located on the back of the heater near each corner. As a heater length exceeds 36", then stud(s) are added in the center of the heater length. This is Solar Products preferred mounting option. The mounting studs size options are as follows:



WIDTH	LENGTH			
	1/4" x 20"	1/2"	3/4"	1"
8mm			25mm	

NUTS

The mounting nuts are commonly located on the back of the heater near each corner. As a heater length exceeds 36", then nut(s) are added in the center of the heater length. The mounting nut size options are as follows:

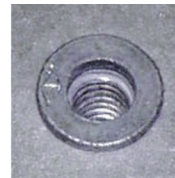

DESCRIPTION	AVAILABLE NUT SIZES		
Snap-in Nuts	1/4" x 20"	5/16" x 18"	3/8" x 16"
Compression Nut	1/4" x 20"	5/16" x 18"	3/8" x 16"

END PIECES

One last mounting option is the use of some special metal clips or brackets on the ends of the heater in lieu of the studs or nuts. This approach can simplify the heater installation for certain applications.



TEMPERATURE SENSING OPTIONS

Custom Thermocouples Available Upon Request

Thermowells are not required on all heaters. Heaters are sometimes controlled with percentage timing devices, which switch the heater on and off based on a time cycle or by means of an optical thermometer. The temperature sensitivity of the application dictates the need for a closed loop, which makes use of a temperature controller and a temperature sensing device, or an open loop, which does not make use of a temperature sensing device and commonly operates on a percentage on/off basis.

END MOUNT THERMOWELL /THERMOCOUPLE

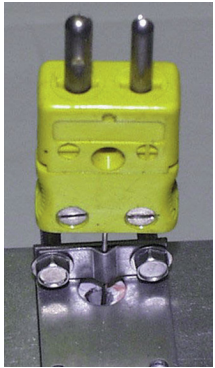

The end mount thermowell is the most common design. The thermowell is either a quartz tube (most common due to faster response) or ceramic tube located parallel to the heating element. The tube is typically 5" (127mm) long and has an inner diameter of 0.157" (4mm). A thermocouple bracket is mounted outside the thermowell tube for the purpose of properly positioning and holding the thermocouple in place.

The thermocouple is then located 4" into the thermowell and fastened using the bracket. It is important to assure that the thermocouple is not over extended into the thermowell. This may result in incorrect temperature readings or heater failure. A thermocouple with a male plug is displayed.

BACKMOUNT THERMOWELL /THERMOCOUPLE

The back mount design makes use of an L-shaped quartz tube that runs perpendicular to the coil toward the back of the heater. The thermowell then makes an arced 90° bend continuing for a short distance parallel to the heating element.

This design is used when heaters are surrounded, not allowing side access. This design requires the use of a 0.040" (1mm) diameter thermocouple in order to make the 90° bend. A thermocouple with a male/female plug combination is displayed. This design is not available for the Q-Series.

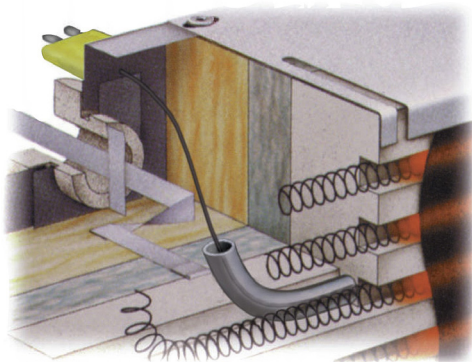

BACKMOUNT BAYONET STYLE

The bayonet style thermowell is sometimes used with the metal, glass or quartz face heaters to measure the actual face temperature (emitting surface) as opposed to the heating element temperature. The thermocouple goes through a bayonet fitting and is compressed using a stainless steel spring. This approach assures that the tip of the T/C makes good contact with the heater face.

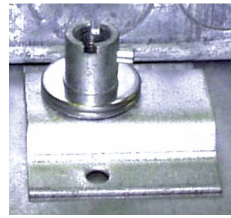

PYROMETERHOLE

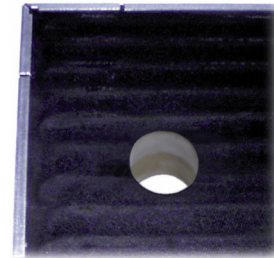

It is becoming more common for equipment manufacturers and end users to make use of optical pyrometers (noncontact thermometers) to sense the product temperature as opposed to the heater temperature. In virtually all applications, the

product temperature is the temperature of choice. The heater temperature is only used as a reference in order to attain a particular product temperature. The price reduction of these devices and the quest for better process control has driven the use of optical pyrometers. For that reason, it is sometimes necessary to provide an opening (1.5" - 2" (38 - 51mm) diameter hole) through the heater where the optical pyrometer can be placed to monitor the product temperature. The hole size can vary based on the specific requirements. A smaller hole is always preferred to avoid non-uniform heating of the product.

WARRANTY

Solar Products panel heaters are covered by a one year warranty against manufacturing defects. This brochure displays many of the options available for panel heaters. Consult Solar Products for heater details on your specific application.