

Electric radiant heat has many benefits over the alternative heating methods of conduction and convection:

•Non-Contact Heating

Radiant heaters have the ability to heat a product without physically contacting it. This can be advantageous when the product must be heated while in motion or when physical contact would contaminate or mar the product's surface finish.

•Fast Response

Low thermal inertia of an infrared radiation heating system eliminates the need for long pre-heat cycles. Since radiant heaters generally require only a few minutes to reach operating temperature, energy savings can also result from turning off the oven during gaps in production.

Radiant heating times are typically less than one-third that of a conventional convection oven. Since radiant energy heats the product directly, without an intervening heat transfer medium such as air, radiant heating can be much faster than convection heating. Convection heating must conduct the heat energy through the boundary film of air that clings to the product's surface. Radiant energy is absorbed at and below the surface of the product and then transferred by conduction throughout the material's thickness.

•High Efficiency

Radiant heaters generate electromagnetic waves that, when intercepted and absorbed by the product, are converted directly to heat. Since they do not necessarily heat the air or surroundings, radiant ovens can be designed to achieve a high level of efficiency.

The energy radiated may also be concentrated, focused, directed, and reflected in the same manner as light, which greatly increases its flexibility and adaptability and reduces energy losses.

•Control Accuracy

Electric radiant heaters can be easily and precisely controlled. They can be zoned to provide uniform heating or a custom distribution of power density. Infrared sensors can sense the actual product temperature and be used to control the heater temperature or line speed.

•Low First-Time Costs

The simplicity of electric infrared systems, the lightness of the structures, and the elimination of massive furnace foundations reduce initial system and installation costs.

•Floor Space Savings

High heat source concentrations quickly increase product temperature allowing for shorter conveyor lengths. Radiant heaters can heat products equally, whether they are moving vertically or horizontally. Compact radiant systems can also be suspended from the ceiling. The value of these floor space saving options will often exceed the first cost of the system.

•Clean Heat

Unlike gas-fired ovens, electric radiant heaters do not produce combustion by-products, so, the product is not contaminated. Low air velocities reduce the possibility of surface contamination by airborne dirt.

What is an Electromagnetic Wave?

All materials are made up of atoms in motion. As heat energy is absorbed by an object, the vibrational motion of its atoms increases. Temperature, or heat, is a measurement of the severity of this vibrational motion. Absolute zero (-460°F) is the temperature at which there is no vibrational motion in an object's atom.

Absolute Temperature in °R = °F + 460

Absolute Temperature in K = °C + 273

Atoms contain positive (protons) and negative (electrons) electrically charged particles. A charged particle creates a field around itself called an electric field. When a charged particle is moved, it generates a magnetic field. Atoms of a hot object vibrate violently. The charged particles that make up the atom are being accelerated back and forth as the “hot” atom oscillates. Each time the atom moves, the electric and magnetic fields created by the charged particles are disturbed. This disturbance in the electric and magnetic fields is called an electromagnetic wave. Hot objects radiate **electromagnetic waves**.

When an electromagnetic wave reaches a cool object, the changing electric and magnetic fields of the electromagnetic wave will act on the charged particles in the atoms of the cool object. The oscillating forces created will tug at the atoms and cause the atoms of the cool object to begin to vibrate. As the vibrational energy of its atoms goes up, so does the temperature of the cool object. In this way, the atoms of the cool object absorb the energy of the electromagnetic wave; a wave created by atoms in a hot object, some distance away. Energy is transferred from a hot object to a cool object without physical contact and without a medium in between.

How do Electromagnetic Waves Move?

Electromagnetic waves are similar to other waves in that they are described by their velocity, frequency, and wavelength. Unlike waves on water or sound waves in the air, electromagnetic waves do not need a medium to travel through. They can travel through the vacuum of space. The radiant energy from the sun travels through 93 million miles of space before reaching the earth.

When the electromagnetic waves are absorbed by an object, they excite the atoms of the object causing them to vibrate, thus raising the temperature. Though the technical term “electromagnetic wave” may sound strange to us, the generic names for this type of energy transfer are very familiar.

- Visible light
- Microwave
- Radio waves
- X-rays
- Infrared radiation

The only difference between these different categories of electromagnetic waves is their wavelength and frequency. They all travel at the same velocity, commonly called the “speed of light.”

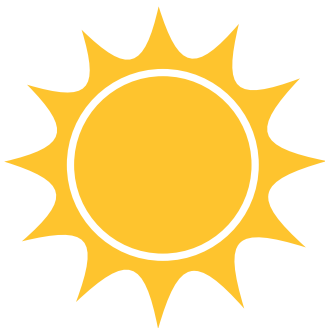

Example: Step from a shaded area to a sunny area on a cold day. Turning towards the sun, your face will feel warm while your back remains cold. Moments before you stepped into this spot the rays from the sun were passing through it, but they did not warm up this space. If they had, your back would feel the warmth as well.

Conclusion: Solar radiation can pass through a space without creating heat. It is only when an object, your face, absorbs the radiant energy that the electromagnetic waves are transformed into the heat that you feel. We tend to relate to the effects of radiant energy absorption because this is all that we can sense, not the electromagnetic waves themselves.

Electromagnetic Spectrum (Fig. 1)

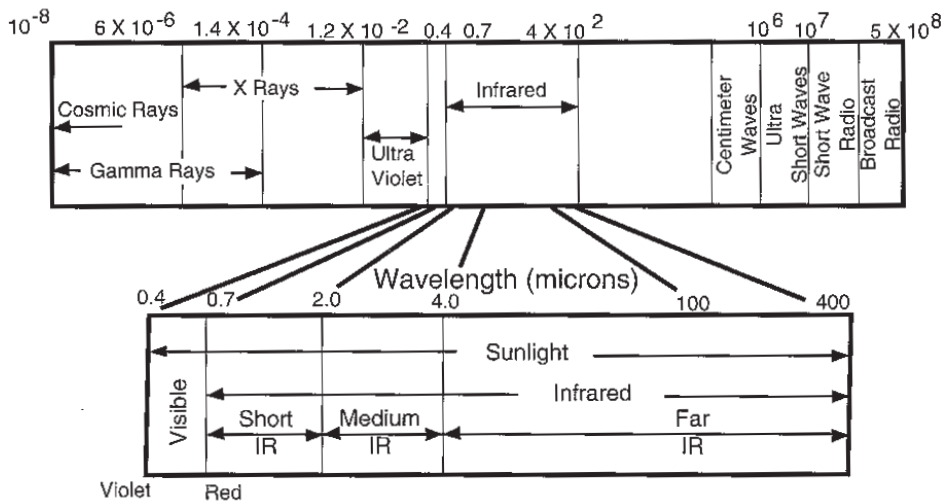

The electromagnetic spectrum shows us how the various frequencies and wave-lengths of electromagnetic waves are categorized.

Wavelength Depends on Temperature

Wavelength is measured in microns. One micron is equal to 1/1,000,000 of a meter or about 0.00004 inches (a human hair is about 50 microns in diameter). Of particular interest is the infrared portion of the spectrum, from about 0.1 to 100 microns, since most of the energy radiated by a heater is in this region.

The amount of energy radiated by a heater and the wavelengths of this energy is determined by the heater's temperature.

For any given heater temperature, the amount of energy radiated can be plotted as a function of the energy's wavelength. When plotted for a series of heater temperatures, this produces a graph called "Planck's Curves" after Max Planck, its originator. Figures 2 through 4 are Planck's Curves plotted with various scales.

Planck's Curve Log Linear Scale (Fig. 2)

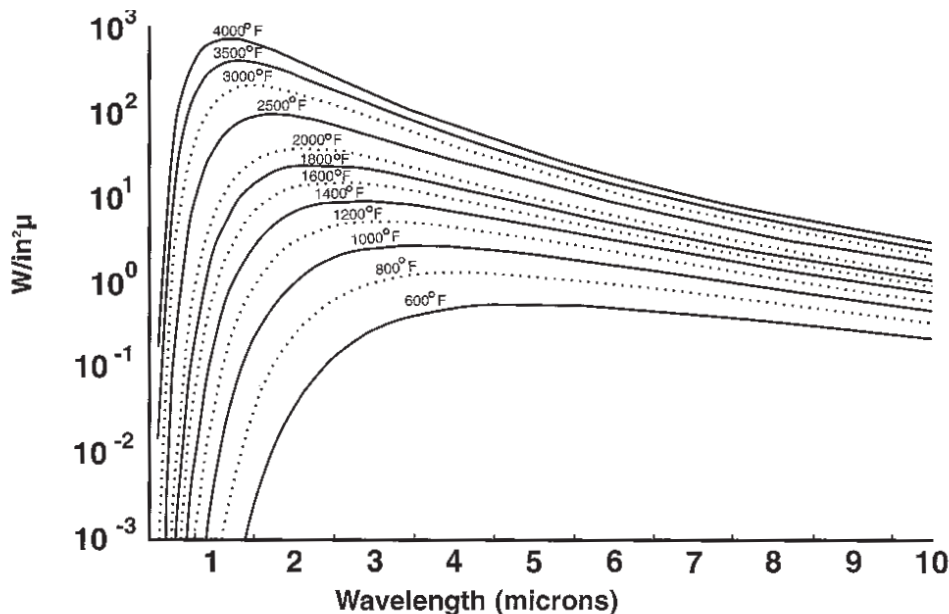

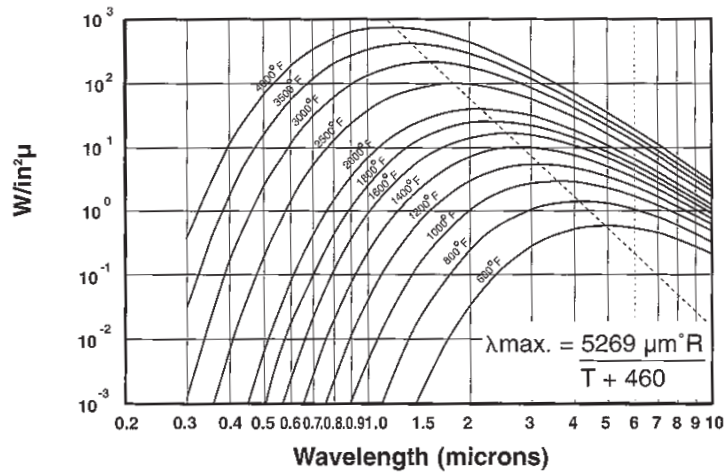

Blackbody Radiation By Micron Band Widths (Fig. 4)

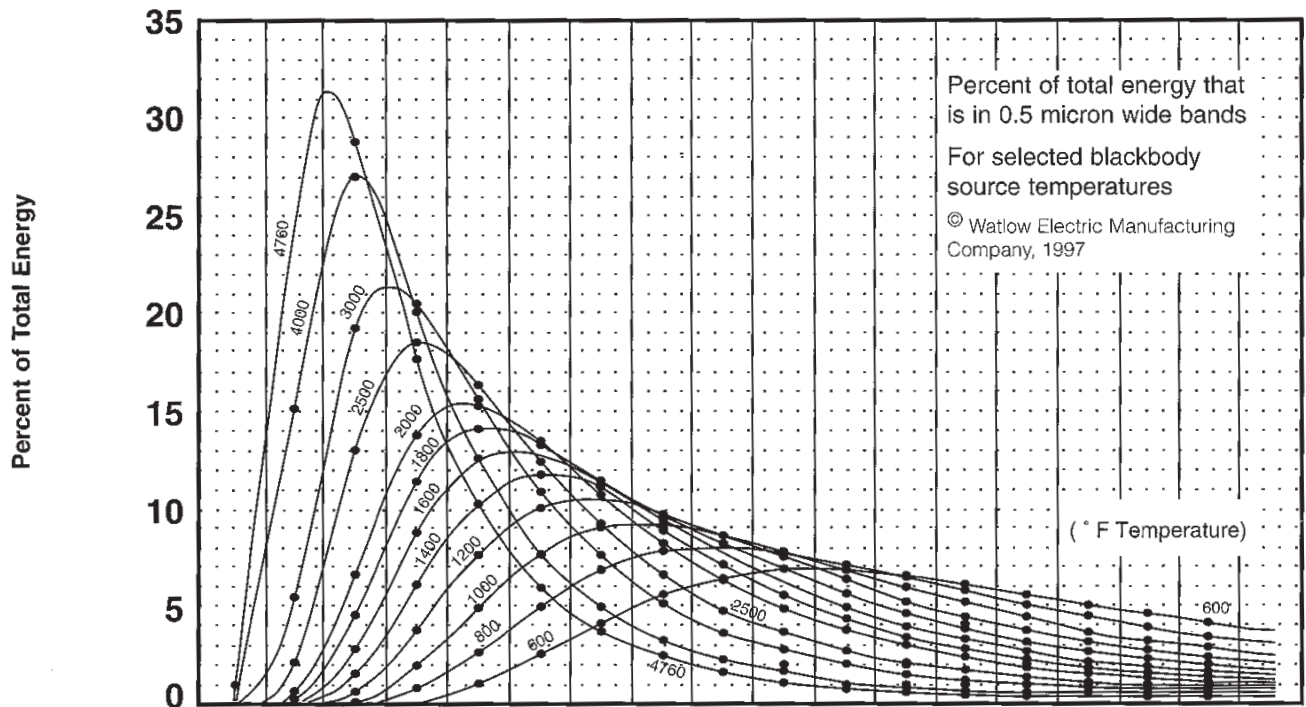

Blackbody				From: 0	0.5	1.0	1.5	2.0	2.5	3.0	3.5	4.0	4.5	5.0	5.5	6.0	6.5	7.0	7.5	8.0	8.5	9.0
° F	° C	° R	K	To: 0.5	1.0	1.5	2.0	2.5	3.0	3.5	4.0	4.5	5.0	5.5	6.0	6.5	7.0	7.5	8.0	8.5	9.0	
600	316	1060	589	0	0	0	0.1	0.1	2.5	4	5.5	6.3	6.7	6.6	6.3	5.9	5.4	4.8	4.4	3.9	3.5	
800	427	1260	700	0	0	0	0.8	2.6	4.9	6.8	7.7	7.9	7.6	7.0	6.3	5.6	4.9	4.3	3.7	3.2	2.9	
1000	538	1460	811	0	0	0.2	2.0	4.9	7.6	9.0	9.1	8.6	7.7	6.7	5.8	5.0	4.3	3.5	3.1	2.7	2.2	
1200	649	1660	922	0	0	0.7	3.8	7.6	9.9	10.4	9.8	8.5	7.4	6.2	5.1	4.3	3.6	3.0	2.5	2.2	1.8	
1400	760	1860	1033	0	0	1.6	6.1	10.2	11.7	11.1	9.8	8.1	6.8	5.5	4.5	3.7	3.0	2.5	2.1	1.8	1.4	
1600	871	2060	1144	0	0.1	2.9	8.8	12.4	12.7	11.3	9.4	7.6	6.1	4.8	3.9	3.1	2.6	2.0	1.7	1.4	1.2	
1800	982	2260	1255	0	0.3	4.7	11.4	14.0	13.3	11.1	8.8	7.0	5.4	4.3	3.3	2.6	2.2	1.7	1.4	1.2	0.8	
2000	1094	2460	1367	0	0.7	6.8	13.8	15.2	13.4	10.6	8.2	6.3	4.8	3.7	2.9	2.2	1.9	1.4	1.2	0.9	0.8	
2500	1371	2960	1644	0	2.3	13.1	18.4	16.3	12.4	9.1	6.6	4.7	3.6	2.6	2.0	1.6	1.2	1.0	0.7	0.7	0.5	
3000	1650	3460	1923	0	5.5	19.2	20.5	15.6	10.9	7.5	5.1	3.6	2.7	1.9	1.4	1.1	0.9	0.7	0.5	0.4	0.3	
4000	2204	4480	2477	0.3	15.4	27.0	20.1	12.6	7.7	4.9	3.2	2.2	1.6	1.0	0.8	0.6	0.5	0.4	0.4	0.3	0.2	
4760	2627	5220	2900	1.0	24.1	29.0	17.9	10.2	5.9	3.6	2.4	1.5	1.0	0.7	0.6	0.4	0.3	0.2	0.2	0.2	0.1	

Radiated Power vs. Wavelength (Fig. 5)

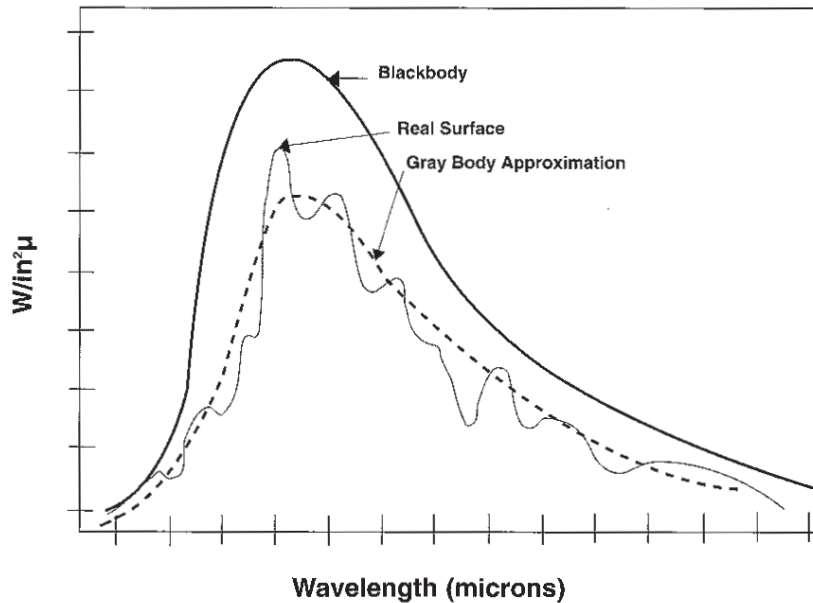

From the curves, it can be seen that a heater radiates energy over a broad spectrum of wavelengths.

It can also be seen that as the heater temperature (T_h) increases:

- The energy radiated increases (as T_h^4).
- The “peak” energy wavelength gets shorter (the curve moves to the left).
- For a given heater, more energy is radiated at all wavelengths.
- A higher percentage of the energy is distributed in a narrower wave band.

The peak energy wavelength for a given heater temperature can be calculated using Wien’s displacement law:

$$\text{Peak Energy Wavelength (microns)} = \frac{5269 \text{ microns } ^\circ\text{R}}{\text{Temp. } (^\circ\text{F}) + 460}$$

For example, if a heater is operating at 1000°F:

$$\text{Peak Wavelength} = \frac{5269 \text{ microns } ^\circ\text{R}}{1460^\circ\text{R}}$$

$$\text{Peak Wavelength} = 3.6 \text{ microns}$$

This corresponds well to Planck’s curves for a 1000°F heater. Many materials do not absorb all wavelengths of radiation equally. For example, plastics typically have “wavelength bands” in the infrared region that are well absorbed, and the balance of the energy is transmitted. For some applications, such as heating thin films of plastic or water, it may be beneficial to select a heater that operates in a temperature range that results in peak energy wavelengths that are well absorbed by the material. If heating a product that absorbs well around 3.6 microns, then, in theory, a 1000°F to 1400°F heater will result in the highest percentage of energy absorption.

Radiant Heat Transfer Formula

When calculating how much heat energy can be put into a product using radiant heaters, there are three important physical parameters to consider:

- **Stefan-Boltzman Equation** is used to calculate the amount of power radiated by the heater.
- **View Factor**, usually determined graphically, describes what percentage of the energy radiated by the heater actually hits the product.
- **Emissivity** of the product determines how much of the incident radiant energy is actually absorbed by the product.

When combined into an equation these parameters are used to calculate the net watts absorbed by a product being heated with radiant panels.

The Stefan-Boltzman Equation

All objects with a temperature above absolute zero radiate energy. The hotter the object, the greater the amount of energy radiated in a given time period (Power= Energy/Time). The Stefan-Boltzman equation calculates the amount of power (watts) radiated by a blackbody surface at temperature T.

$$\frac{\text{Watts Radiated}}{\text{Area}} = \text{Constant} \times (\text{absolute temperature})^4$$

$$\frac{\text{Watts}}{\text{ft}^2} = \frac{(0.1714 \times 10^{-8} \text{ BTU/Hrft}^2 \text{ } ^\circ\text{R}) (\text{ } ^\circ\text{F} + 460)^4}{3.412 \text{ BTU/watt hr}}$$

From this equation, it can be seen that the watts radiated from the object depends on the absolute temperature of the radiating surface to the **fourth power**. This means that a small increase in the temperature will produce a large increase in the radiated watts. Figure 6 shows the relationship between radiated power and temperature.

Radiated Power vs. Temperature (Fig. 6)

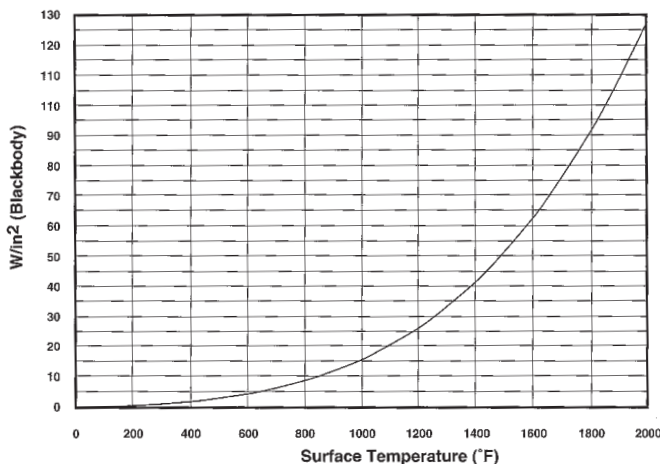

Temperature is the driving force in radiant energy. The Stefan-Boltzman equation is the heart of the formula used to calculate the radiant energy transferred from heater to product.

A surface at 1200°F radiates over twice the energy that it radiates at 900°F.

In a typical radiant application, a heater radiates energy to a product. As the temperature of the product increases, it begins to radiate a significant amount of energy as well. To determine the net power radiated, the power radiated by the product must be subtracted from that radiated by the heater. The equation thus becomes:

$$\frac{\text{Net Watts Radiated}}{\text{Area}} = \text{Constant} [(\text{Heater Absolute Temperature})^4 - (\text{Product Absolute Temperature})^4]$$

This equation is plotted for various heater and product temperatures in Figure 7. From the graph it can be seen that the greater the temperature difference between the heater and the product, the greater the net watts radiated. When the heater and product temperature are equal, the net watts radiated is zero.

Stefan-Boltzman Equation (Fig. 7)

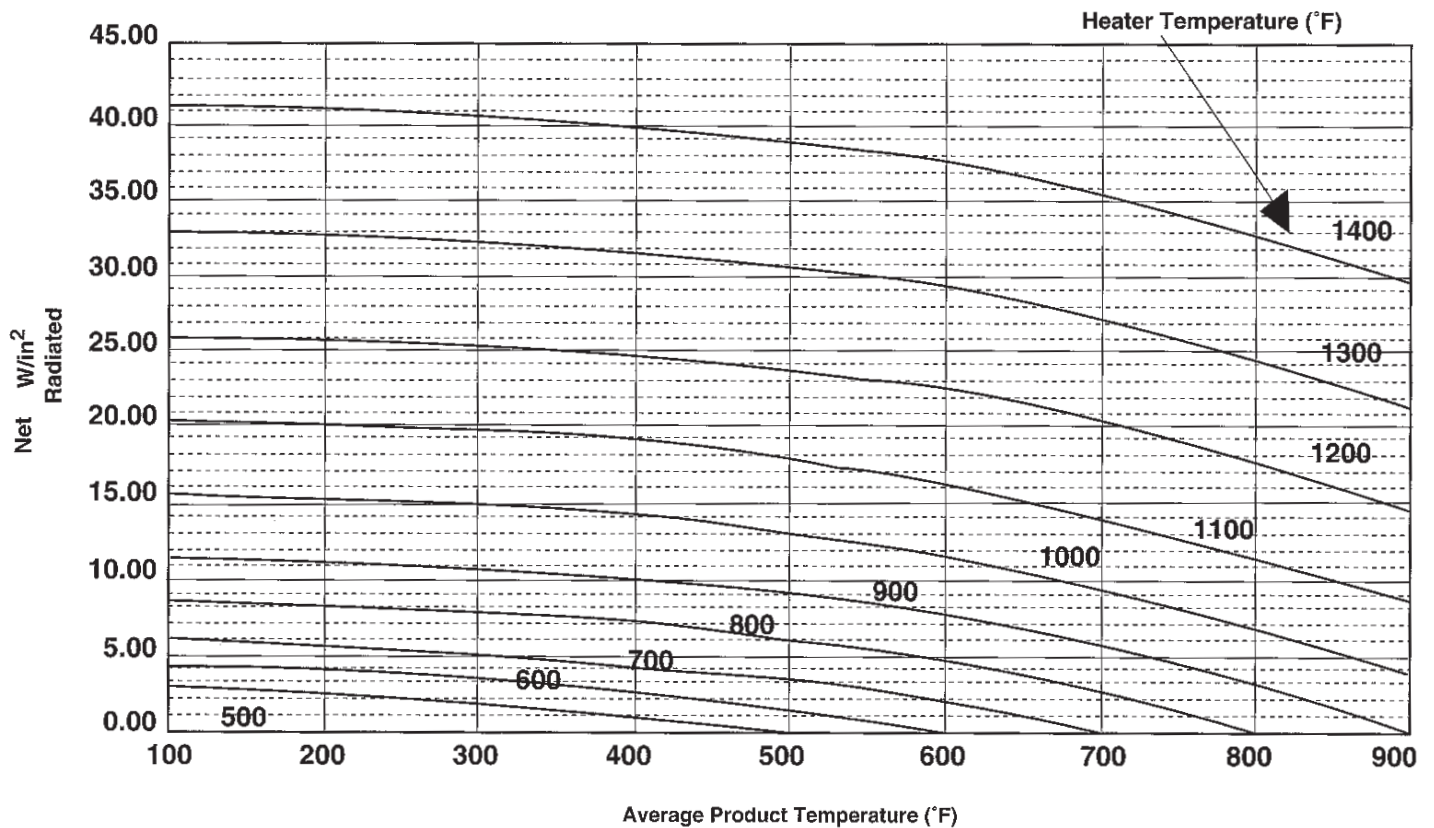

$$\frac{\text{Net watts}}{\text{in}^2} = 3.4885 \times 10^{-12} [(T_h + 460)^4 - (T_p + 460)^4]$$

T_h = Heater Temperature (°F)
 T_p = Product Temperature (°F)

The View Factor

The Stefan-Boltzman equation calculates the net energy radiated by the heater. It doesn't calculate how much of the radiated energy actually hits the product. There is a geometric relationship between the size of the heater and product, and the distance between them, that determines how much of the radiated energy the product intercepts. This relationship is called the **View Factor**.

The view factor can be determined graphically. Using Figure 8, the view factor can be determined for a flat rectangular heater radiating toward a parallel flat rectangular product. Consider a radiant heater, 20 inch X 40 inch, radiating towards a product of the same size and 10 inches away. First calculate M and N:

$$M = \frac{\text{Heater Width}}{\text{Distance to Product}} = \frac{20 \text{ in}}{10 \text{ in}} = 2$$

$$N = \frac{\text{Heater Length}}{\text{Distance to Product}} = \frac{40 \text{ in}}{10 \text{ in}} = 4$$

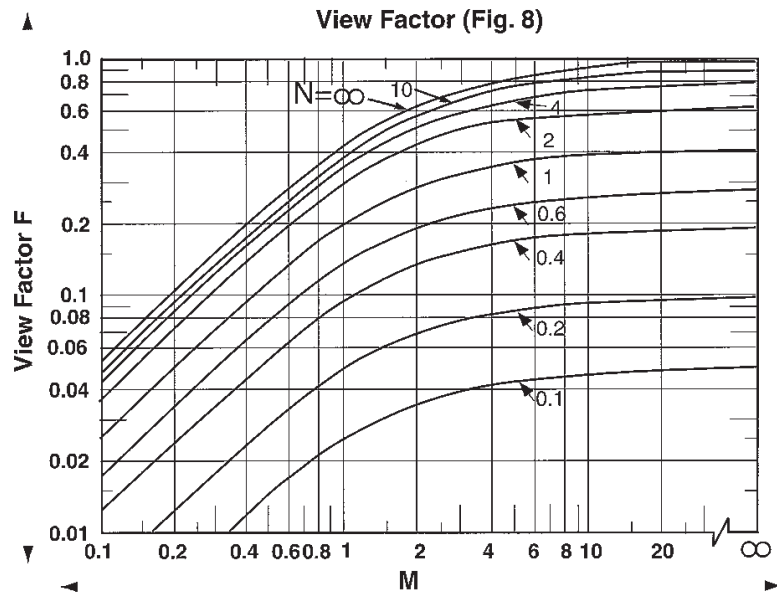

$$M = \frac{\text{Heater Width}}{\text{Distance to Product}}$$

$$N = \frac{\text{Heater Length}}{\text{Distance to Product}}$$

Note: M and N are interchangeable

Looking at Figure 8, the view factor (F) is: $F = 0.5$

This indicates that 50 percent (50%) of the energy radiated by the heater will strike the product.

To examine the relationship distance plays, assume the same radiant heater and product are now five inches apart, where:

$$M = \frac{20 \text{ in}}{5 \text{ in}} = 4$$

$$N = \frac{40 \text{ in}}{5 \text{ in}} = 8$$

The view factor tells us the percentage of the radiant energy leaving the heater that is intercepted by the product. One could say that the view factor tells us how good a view the product has of the heater

View factor graphs exist for physical configurations other than parallel planes, such as concentric cylinders and non-parallel planes. Consult Heat and Sensor Technology in these cases.

Looking at Figure 8, the new view factor (F) is: $F = 0.7$

Now 70 percent (70%) of the energy radiated by the panel will reach the product. By moving the heater from 10 inches to five inches from the product, the product receives 40 percent (40%) more energy.

The closer the heater is to the product, the more efficient the heat transfer will be. The heater to product distance will be determined by physical constraints of the equipment or by the uniformity of the radiant heat source. In applications where the heater to product distance is large, the efficiency can be improved by adding side reflectors of polished aluminum.

Emissivity and Absorptivity

Not all the radiant energy that reaches the product is absorbed. Some may be reflected and some transmitted right through. Only absorbed energy will serve to heat the product.

$$\text{Total Incident Energy} = \text{Absorbed} + \text{Reflected} + \text{Transmitted}$$

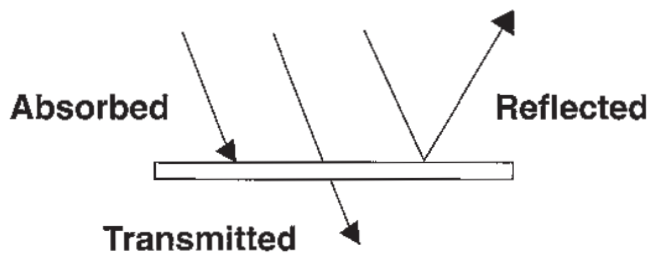

It is the physical nature of the product that determines how well the product absorbs the radiant energy that strikes it. This same physical property determines how well a surface emits radiant energy. At the same temperature and wavelength, absorptivity and emissivity are equal. From here on, the term "emissivity" will be used for the numerical value that describes either the ability to absorb or emit radiant energy.

What is a Blackbody?

A perfect absorbing surface will absorb all the radiant energy that strikes it. Such a surface has an emissivity equal to one (1) and is called a blackbody. All real surfaces have emissivities less than one (1). In general, non-metallic surfaces have good emissivities (close to 1) and shiny metallic surfaces have low emissivities (close to 0). Shiny metal surfaces are good reflectors. Thin films may have low emissivities because they transmit a large part of the incident energy.

Absorption vs. Wavelength (Fig. 9)

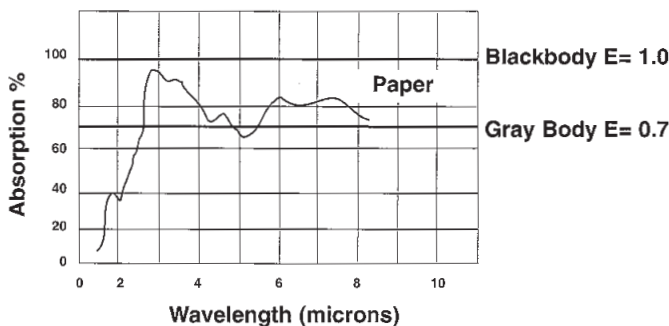

Emissivity is often the parameter that is the most difficult to accurately determine when making radiant calculations. In some cases, emissivity can be approximated with a constant value. For example, (Figure 9) a surface with an emissivity of 0.7 will absorb 70 percent (70%) of the radiant energy that strikes it. Such a surface is called a gray body. The emissivity of many real surfaces varies with the product thickness, temperature, and the wavelength of the incident energy.

The task of calculating the percentage of radiant energy absorbed by the product can be simplified if the emissivity of the product can be approximated as a constant.

Spectral Absorption Curve For Water (Fig. 10)

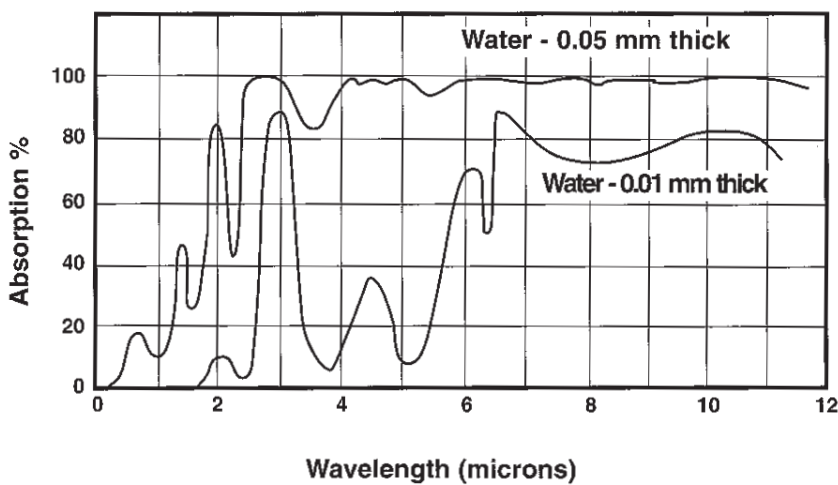

It is interesting to note that Figure 10 indicates that much of the short wavelength infrared and visible radiation is transmitted through the water. This is consistent with the observation that water is largely transparent to light (you can see the bottom of a swimming pool).

Figure 10 illustrates that a film of water thicker than 0.05 mm will absorb most of the infrared radiation longer than two microns. Planck's curves (Figure 4) indicates that a heater operating in the 1000° F - 1500° F range produces almost all its energy in wavelengths longer than two microns. If calculating the radiant energy absorption of a water film thicker than 0.002 inches (0.05 mm) that is being heated by a heater operating under 1500° F, the emissivity of the water can be considered a constant 0.93.

Emissivity Values

Some common examples of emissivities that can be considered constant (gray bodies) in the medium to long wavelength infrared region are shown below:

Emissivity Values (Fig.11)

Material	Emissivity	Material	Emissivity
Blackbody	1	Most Paint	0.9
Wood	0.9	Fire Brick	0.8
Rubber	0.9	Polished Silver	0.01
Aluminum Polished	0.03	Glass	0.8-0.9
Aluminum Oxidized	0.24	Steel Polished	0.07
Water	0.93	Steel Oxidized	0.80
Heat & Sensor Radiant Panel	0.85	Lamp Black	0.96

Heater Emissivity

Just as the surface condition of the product determines how well it absorbs radiant energy, the surface conditions of the heater determines how well it emits radiant energy.

The Stefan Boltzman equation computes the energy radiation from a blackbody (Emissivity = 1). All real surfaces radiate less.

To calculate the watts radiated from a real surface, correction for the emissivity of that surface must be made:

Watts Radiated = Stefan-Boltzman Equation x Emissivity Heater

The emissivity of the heater (Eh) is a constant 0.85. If the emissivity of the product (Ep) can also be considered a constant, the wattage absorbed by the product can be determined with the following equation:

Watts Absorbed = Stefan-Boltzman Equation x Eh x Ep x View Factor

This represents the simplest case. If the product is opaque and somewhat reflective, then the reflected energy will bounce back to the heater, and some will be reflected back to the product for a second chance at absorption. In this case, E effective is used instead of Eh x Ep.

$$E \text{ effective} = \frac{1}{\frac{1}{E_h} + \frac{1}{E_p} - 1}$$

E effective is always greater than Eh x Ep

If the emissivity of the product cannot be considered a constant, an emissivity spectrum should be obtained from the material supplier. Most plastic films and sheets fall into this category. Figure 12 is a transmission spectrum for polyethylene 0.1 mm thick (0.004 in)

Transmission Spectrum for Polyethylene (Fig. 12)

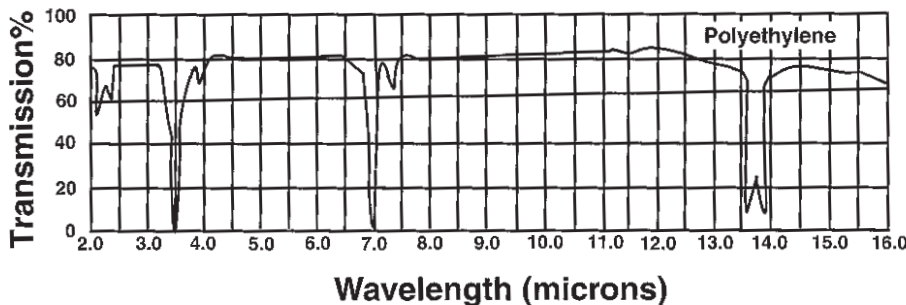

The Heat & Sensor radiant panels are manufactured with a high emissivity, hot-face coating with an emissivity of 0.85. They radiate 85 percent (85%) as much as a blackbody at the same temperature. In the infrared region, this emissivity is relatively wavelength independent, making Heat & Sensor panels effective gray body radiators. Note: This does not mean that the heater is only 85 percent (85%) efficient. It means the heater will operate somewhat hotter than a blackbody radiating the same wattage.

Figure 12 shows that polyethylene has absorption peaks in the 3.2 to 3.7 and 6.8 to 7.5 micron range. For maximum efficiency the peak energy wavelength of the heater should be about 3.5 microns. Use Wien's displacement law or see Figure 4 to determine heater temperature:

$$\text{Heater Temperature} = \frac{5269 \text{ microns}}{\text{Peak Energy Wavelength}} - 460^\circ$$

$$\text{Heater Temperature} = \frac{5269 - 460}{3.5}$$

$$\text{Heater Temperature} = 1045^\circ\text{F}$$

A heater operating at about 1045°F will have a peak energy wavelength of 3.5 microns. This matches the peak absorption range of polyethylene (Figure 12).

Radiant Energy Ratios For Several Blackbody Temperatures (Fig. 13)

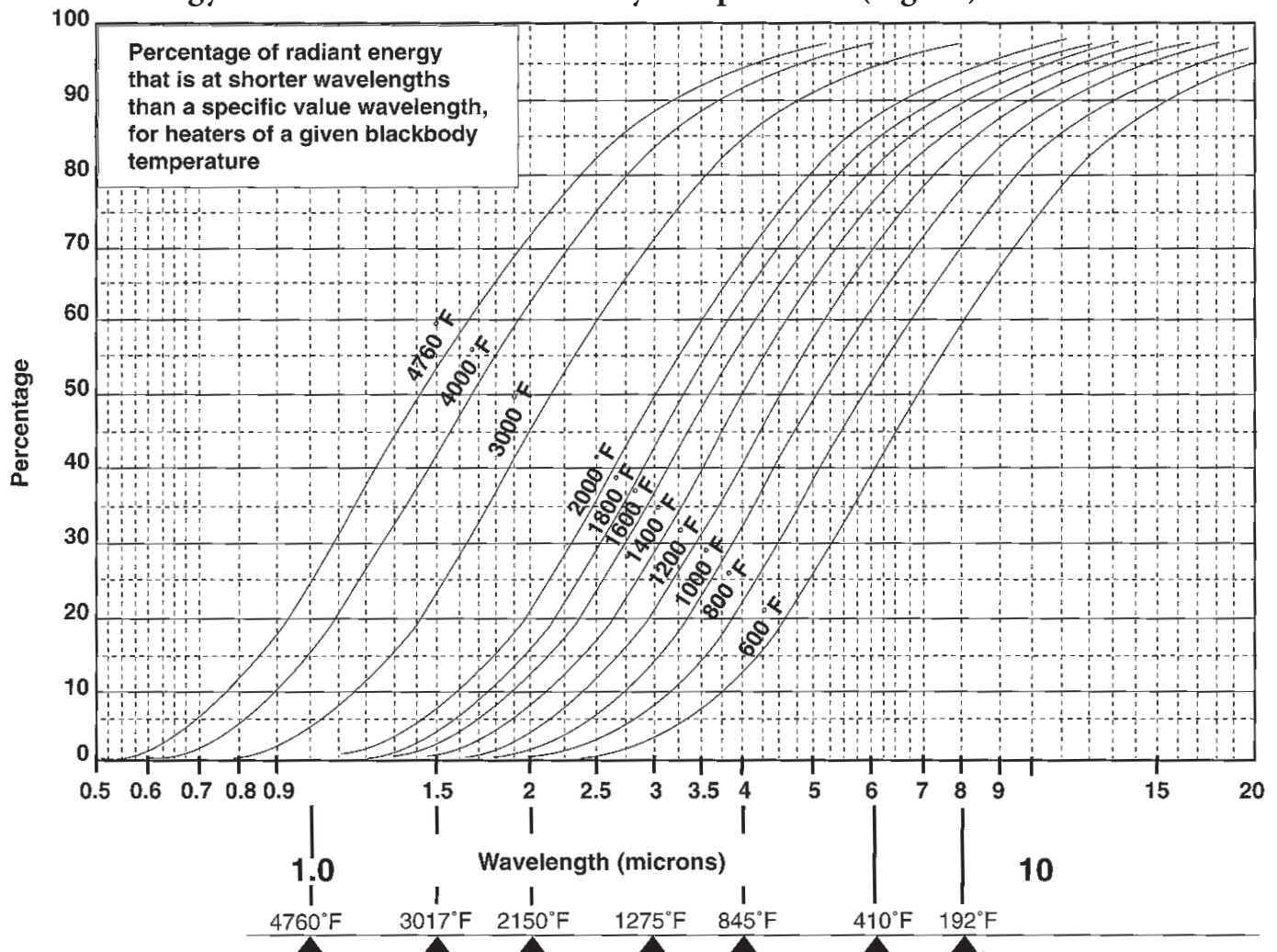

Source Temperatures (°F) For The Peak Radiation Band's Wavelength (Wien's Displacement Law)

This information is useful for selecting a heater temperature operating range and, thus, the type of heater construction to produce the approximate wavelength for good absorption. Remember, the heater always produces a broad range of wavelengths around the peak energy wavelength; precise heater temperature tuning is not very meaningful. The actual heater operating temperatures will be determined by other factors such as line speed and material thickness. A few hundred degrees either way does not have much impact on the wavelengths produced by the heater. It will, however, have a big effect on the amount of energy radiated since this depends on the temperature to the fourth power. Figure 13 can be used to determine what percentage of the energy radiated by a heater at 1000 F lies in the 3.2 to 3.7 micron band and 6.8 to 8.0 micron band.

Percent of energy with wavelengths less than 3.2 microns = 17%

Percent of energy with wavelengths less than 3.7 microns = 25%

Net energy in the 3.2 to 3.7 micron band = 8%

Percent of energy with wavelengths less than 6.8 microns = 69%

Percent of energy with wavelengths less than 8.0 microns = 77%

Net energy in the 6.8 to 8.0 micron band = 8%

Energy absorbed = 16% of incident non-reflected energy

Most plastics reflect about five percent (5%) of the radiant energy, so roughly speaking:

Energy striking the plastic = 5% reflected + 79% transmitted + 16% absorbed

What happens to the energy that is not absorbed? It passes through the plastic and hits whatever is in its path. If there is another heater or an aluminum reflector, most of this energy will be redirected back into the plastic. With proper oven design, the efficiency can be much greater than 15.2 percent (15.2%); but the rate of energy absorption is still determined by this value. Note also that 1 mm (0.004 in) thick plastic is very thin and a thicker film will absorb more. See example problem #3 (page 24) for a step-by-step solution to the plastic heating problem.

Note: Even if the heater temperature is raised to 1200° F, these percentages change by less than a percent, so precise tuning of the heater is not important.

Problem Solving

Steps to Solving Radiant Application Problems

Broadly speaking, there are three steps to determining the correct radiant heater solution for an application: First, collect the necessary application information. Sometimes educated guesses are required here, but, remember, that the accuracy of the calculations depends on the accuracy of the numbers put into them.

Second, calculate how much wattage is required to produce the desired temperature change in the product. This part of the problem is solved using the conventional heat transfer equations and problem solving methods. It does not involve radiant heat calculations.

Third, determine what radiant heater size and temperature is needed to put the required wattage into the product. For this, use the radiant heat transfer equation.

Step 1: Collect Application Information

- Initial and final material temperature
- Heat-up time
- Specific heat of material
- Density or weight of material
- Material size
- Heat of vaporization/fusion of material, if applicable
- Conveyor speed, if applicable
- Emissivity of material or absorption spectrum
- Heater to material distance
- Proposed heater layout: size, spacing, heating one or both sides
- Are there secondary heat loads, such as air, conveyor, etc.?

Step 2: Determine the Required Wattage

Use conventional heat transfer equations to determine the wattage that must be absorbed by the material to produce the desired changes. The most commonly used equations are listed below:

Change in Temperature:

$$W/in^2 = \frac{\text{Weight (lbs)/in}^2 \times \text{Specific Heat} \times \text{Change in Temperature (}^\circ\text{F)}}{\text{Time (hr)} \times 3.412 \text{ BTU/watt hr}}$$

Change in State:

$$W/in^2 = \frac{\text{Weight (lbs)/in}^2 \times \text{Heat of Fusion or Vaporization}}{\text{Time (hr)} \times 3.412 \text{ BTU/watt hr}}$$

These equations determine how much heat must go into the product. In many cases, convection losses from the product can be neglected; since the ambient air between the radiant heater and product is usually hotter than the product, some convection heating takes place. If air is vented through the oven to carry away solvents or water vapor, then the wattage used to heat this air must be considered.

Warning:

Calculations provide good results when all the variables are known and all the heat loads are included. In real world applications, many assumptions are made.

Heat and Sensor recommends that tests be performed to substantiate calculations whenever possible. Heat and Sensor has extensive testing facilities to evaluate the radiant heat requirements of your process. In cases where sending samples to Heat and Sensor is not feasible, test heaters and controls for on-site testing at your location are available. Your local Heat and Sensor representative is available to help you with product testing at either your facility or Heat and Sensor's.

Density and specific heat for many materials can be found in the Heat and Sensor Application Guide.

Step3: Compute the Absorbed Wattage for a Proposed Heater Array

The equation that describes radiant heat transfer can be written:

$$W/in^2 = \frac{S(Th^4 - Tp^4) \times E \times F}{144 \text{ in}^2/\text{ft}^2 \times 3.412 \text{ BTU/watt hr}}$$

W/in² = Watts per square inch absorbed by the product

S = Stefan-Boltzman Constant = 0.1714 x 10⁻⁸ BTU/hr ft² °R⁴

F = View Factor (From Figure 8)

Th = Heater Temperature in °R = °F + 460

Tp = Product Temperature in °R = °F + 460

Since the product temperature Tp is continuously changing, the average product temperature is used:

$$\text{Average Product Temperature} = \frac{T (\text{Initial}) + T (\text{Final})}{2}$$

E = Effective Emissivity. When heater and product are parallel planes:

$$E = \frac{1}{\frac{1}{E_h} + \frac{1}{E_p} - 1}$$

Eh = Emissivity Heater = 0.85

Ep = Emissivity Product (gray body)

If the product cannot be assumed to be a gray body, then an absorption spectrum must be obtained. Use the reflectivity component for Ep and use Figure 13 to evaluate the percentage of energy radiated by the heater in the absorption bands of the product. (See example problem #3.)

If all variables can be determined and plugged into the radiant heat transfer equation the watts per square inch absorbed by the product can be calculated. Or if the required watts per square inch into the product is known then the equation can be used to determine the necessary heater temperature.

The Stefan-Boltzman portion of the equation:

$$\frac{S(Th^4 - Tp^4)}{144 \text{ in}^2/\text{ft}^2 \times 3.412 \text{ BTU/watt hr}}$$

It has been graphed for various heater temperatures, in Figure 7. Using this graph eliminates calculating the T⁴ values and makes it very easy to try a variety of heater temperatures quickly or to solve for heater temperature.

Example #1: Heating an Opaque Product

A manufacturing process requires that 24 inch X 24 inch X 0.031 inch pieces of 304 stainless steel be heated to 300°F in one minute. The stainless steel has a coating with an emissivity of 0.80. A radiant panel can be located two inches above the metal.

1. Collect data, make assumptions. To uniformly heat the product, choose a heater size that overlaps an amount equal to the distance between the heater and the sheet of steel, i.e.:

Heater Size = 28 inch x 28 inch

- $\Delta T = 300 - 60 = 240^\circ\text{F}$
- $\text{Weight}/\text{in}^2 = 5001\text{bs}/\text{ft}^3 \times 1\text{ft}^3/1728\text{in}^3 \times 0.031 \text{ inch thick} = 0.008971\text{bs}/\text{in}^2 *$
- Specific Heat = 0.12 BTU/lb°F*
- Time = 1 minute = 0.0167 hrs
- Emissivity of Product = $E_p = 0.80$

2. Determine the wattage required to heat one square inch of the material.

$$\text{Watts} = \frac{\text{Weight} \times \text{Specific Heat} \times \Delta T}{\text{Time} \times 3.412 \text{ BTU/watt hr}}$$

$$\frac{\text{Watts}}{\text{in}^2} = \frac{0.008971\text{bs}/\text{in}^2 \times 0.12 \text{ BTU}/\text{lb}^\circ\text{F} \times 240^\circ\text{F}}{0.0167 \text{ hrs.} \times 3.412 \text{ BTU/watt hr}}$$

$$\frac{\text{Watts}}{\text{in}^2} = 4.54 \text{ W}/\text{in}^2$$

3. Using the radiant heat transfer equation, determine the radiant heater temperature needed to transfer the required wattage found above.

$$\text{W}/\text{in}^2 = \frac{S(\text{Th}^4 - \text{Tp}^4) \times E \times F}{144 \text{ in}^2/\text{ft}^2 \times 3.412 \text{ BTU/watt hr}}$$

- A. Compute the view factor F

The heater is 28 inch x 28 inch, located two inches from the product.

$$M = \frac{28}{2} = 14 \qquad N = \frac{28}{2} = 14$$

(From Figure 8) $F = 0.85$

- B. Compute the effective emissivity (E) Emissivity of heater = $E_h = 0.85$

* Can be found in the Application Guide

$$E = \frac{1}{\frac{1}{E_h} + \frac{1}{E_p} - 1} = \frac{1}{\frac{1}{0.85} + \frac{1}{0.8} - 1} = 0.70$$

C. Determine the average product temperature (T_p)

$$T_p = \frac{300 + 60}{2} = 180^\circ\text{F} = 640^\circ\text{R}$$

D. Plug into the radiant heat transfer equation

$$W/\text{in}^2 = \frac{S(\text{Th}^4 - T_p^4) \times E \times F}{144 \text{ in}^2/\text{ft}^2 \times 3.412 \text{ BTU/watt hr}}$$

From above we found:

$$E = 0.70$$

$$F = 0.85$$

$$T_p = 640^\circ\text{R}$$

$$\text{Required } W/\text{in}^2 = 4.54 \text{ W/in}^2$$

Therefore:

$$4.54 \text{ W/in}^2 = \frac{S(\text{Th}^4 - (640)^4) \times 0.7 \times 0.85}{144 \text{ in}^2/\text{ft}^2 \times 3.412 \text{ BTU/watt hr}}$$

$$7.6 \text{ W/in}^2 = \frac{S(\text{Th}^4 - (640)^4)}{144 \text{ in}^2/\text{ft}^2 \times 3.412 \text{ BTU/watt hr}}$$

$$S = 0.1714 \times 10^{-8} \text{ BTU/hr ft}^2 \text{ }^\circ\text{R}^4$$

E. Determine the required heater temperature (T_h)

All information required to solve the above equation for the heater temperature (T_h) is now available. Note that the equation gives T_h in $^\circ\text{R}$.

$$T_h (^\circ\text{F}) = T_h (^\circ\text{R}) - 460$$

Another option is to use Figure 7

$$\text{Radiated watts} = 7.6 \text{ W/in}^2$$

$$\text{Average } T_p = 180^\circ\text{F}$$

From the graph or the calculation, find:

$$T_h = 780^\circ\text{F}$$

To transfer the required watts, the heater must operate at 780°F .

Comments/Questions

What is the required heater watt density?

If selecting a Heat and Sensor Technology Panelmax 1120 for this application, Figure 18 shows that this heater requires about 9 W/in² to maintain 780° F face temperature in open air. In this application, slightly less would be required since some of the radiant energy that is reflected off of the 0.80 emissivity surface of the metal is reflected back into the heater and re-absorbed. This would be a much more significant factor if the product surface had a lower emissivity, say 0.5.

What about losses off the surface of the metal as it heats up?

Generally, the air temperature between the heater and the product is higher than the product temperature, so some convection heating takes place. In this application, assume the plate is resting on a good heat insulator and there is very little air movement. If this is not the case, then these losses must be estimated and added to the required wattage determined above.

Example #2: Drying a Moving Web of Cloth

A fabric drying process requires that water be evaporated from a five foot web of cotton cloth moving at 10 feet per minute. The dry cloth weighs 0.0356 pounds per square foot. The wet cloth weighs 0.0762 pounds per square foot. The wet cloth will enter the drying oven at 60° F. Heaters can be located within four inches above and below the cloth.

1. Collect the data, make assumptions.

Assume a cloth exit temperature of 250°F

- ΔT cloth = 250° F - 60° F = 190° F
- ΔT water = 212° F - 60° F = 152° F
- ΔT steam = 250° F - 212° F = 38° F
- Specific heat cloth* = 0.31 BTU/lb° F
- Specific heat water* = 1.0 BTU/lb° F
- Specific heat steam* = 0.482 BTU/lb° F
- Heat of vaporization of water* = 965 BTU/lb
- Weight of dry cloth = 0.0356 lb/ft²
- Weight of water = wet cloth - dry cloth = 0.0762 lb/ft² - 0.0356 lb/ft² = 0.0406 lb/ft²
- Emissivity of textiles (dry) = 0.77
- Emissivity of water = 0.92
- Emissivity of wet cloth (best guess) = 0.85

* These values can be found in the Application Guide.

2. Determine the wattage required to completely dry the wet cloth. There are four parts to this problem.

A. Watts required to raise the temperature of the cloth to 250°F.
The area per hour being heated is:

$$10 \text{ ft/min} \times 5 \text{ ft wide} \times 60 \text{ min/hr} = 3000 \text{ ft}^2/\text{hr}$$

$$\text{The weight of cloth} = 3000 \text{ ft}^2/\text{hr} \times 0.0356 \text{ lb/ft}^2 = 106.8 \text{ lb/hr}$$

$$\text{Watts to heat cloth} = \frac{\text{Wt} \times \text{Specific Heat} \times \Delta T}{\text{Time} \times 3.412 \text{ BTU/watt hr}}$$

$$\text{Watts to heat cloth} = \frac{106.8 \text{ lb.} \times 0.31 \text{ BTU/lb}^\circ\text{F} \times 190^\circ\text{F}}{1 \text{ hr} \times 3.412 \text{ BTU/watt hr}}$$

$$\text{Watts to heat cloth} = 1,844 \text{ watts}$$

B. Watts required to raise the temperature of the water to 212°F.

$$\text{The weight of the water} = 3000 \text{ ft}^2/\text{hr} \times 0.0406 \text{ lb/ft}^2 = 121.8 \text{ lb/hr}$$

$$\text{Watts to heat water} = \frac{121.8 \text{ lb} \times 1 \text{ BTU/lb}^\circ\text{F} \times 152^\circ\text{F}}{1 \text{ hr} \times 3.412 \text{ BTU/watt hr}}$$

$$\text{Watts to heat water} = 5426 \text{ watts}$$

C. Watts required to vaporize the water.

$$\text{Watts to vaporize water} = \frac{\text{Weight of Water} \times \text{Heat of Vaporization}}{\text{Time} \times 3.412 \text{ BTU/watt hr}}$$

$$\text{Watts to vaporize water} = \frac{121.8 \text{ lb} \times 965 \text{ BTU/lb}}{1 \text{ hr} \times 3.412 \text{ BTU/watt hr}}$$

$$\text{Watts to vaporize water} = 34,448 \text{ watts}$$

D. Watts required to raise the temperature of the steam from 212°F to 250°F.

$$\text{Watts to heat steam} = \frac{121.8 \text{ lb} \times 0.482 \text{ BTU/lb }^\circ\text{F} \times 38^\circ\text{F}}{1 \text{ hr} \times 3.412 \text{ BTU/watt hr}}$$

$$\text{Watts to heat steam} = 654 \text{ watts}$$

Heat cloth	1,844 watts
Heat water	5,426 watts
Vaporize water	34,448 watts
Heat steam	<u>654 watts</u>
Total watts	42,372 watts

Note: The energy required to vaporize the water far exceeds all the other requirements combined.

3. Determine the heater temperature and array size required to transfer the needed wattage.

A. Determine the view factor (F).

Heating a web of material results in negligible losses out the five foot sides. All the energy radiated in the direction of the web will hit the material.

$$M = \infty$$
$$N = 60 = 15x$$

Using Figure 8 and $M = \infty$, $N = 15$, we find $F = 0.93$

B. Calculate the effective emissivity.

$$\text{Emissivity of heater} = E_h = 0.85$$
$$\text{Emissivity of product} = E_p = 0.85$$

$$E = \frac{1}{\frac{1}{E_h} + \frac{1}{E_p} - 1} = \frac{1}{\frac{1}{0.85} + \frac{1}{0.85} - 1} = 0.74$$

C. Determine the net watts transferred to the product.

To plug into the Stefan Boltzman equation, heater temperature (T_h) needs to be known. Continue the plan to use Panelmax 1120 radiant panels. The maximum temperature for this heater is 1100°F . To allow for adjustment, select an operating temperature of 1000°F .

$$T_h = 1000^\circ\text{F} = 1460^\circ\text{R}$$

$$\text{The average product temperature} = \frac{(T)_{\text{final}} + (T)_{\text{initial}}}{2}$$

$$= \frac{250 + 60}{2} = 155^\circ\text{F} = 615^\circ\text{R}$$

$$T_p = 615^\circ\text{R}$$

$$\text{Net watts transferred} = \frac{S(T_h^4 - T_p^4) \times E \times F}{144 \text{ in/ft}^2 \times 3.412 \text{ BTU/watt hr}}$$

$$\text{Net watts transferred} = \frac{S(1460^4 - 615^4) \times 0.74 \times 0.93}{144 \text{ in/ft}^2 \times 3.412 \text{ BTU/watt hr}}$$

Solving this equation or using Figure 7 finds:

$$\text{Net watts transferred} = 15.2 \text{ W/in}^2 \times 0.74 \times 0.93$$

$$\text{Net watts transferred} = 10.4 \text{ W/in}^2 \text{ per side}$$

$$2 \text{ sides} \times 10.1 \text{ W/in}^2 = 20.8 \text{ W/in}^2 \text{ both sides}$$

D. The required oven length can now be determined.

Oven length x width x 20.8 W/in² = watts required = 42,372 watts

$$\text{Oven length} = \frac{42,372 \text{ watt}}{5 \text{ ft} \times \frac{12 \text{ in}}{\text{ft}} \times 20.8 \text{ W/in}^2}$$

Oven length = 34 in

Comments/Questions

What should the heater wattage be?

Figure 18 shows that a Panelmax 1120 panel requires approximately 17 W/in² to achieve 1000° F in open air. In the actual application, a slightly lower wattage is required, since some of the radiated energy is reflected and reradiated back into the heater. Since temperature controllers will be used to maintain the required heater temperature, any excess power will not be used or wasted and a higher wattage provides room for adjustment. However, a grossly over-powered system will require unnecessarily high amperage service, large switching devices, and large gauge lead wire.

If large amounts of water or solvent are being dried from an object, it is necessary to vent air through the oven to carry the vapors away. The density of flammable vapors, in particular, must be carefully controlled to prevent explosions or fire. Substantial amounts of vented or forced air flow through the oven will convect heat away from the heaters and product, and additional wattage will be required.

What if the oven user could not accommodate an oven length of 35 inches?

Higher temperature and power heaters could be used to shorten the oven, but temperature and speed control become more critical. Our calculations indicate that almost all of the power used goes into vaporizing the water. Once the water is gone, the temperature of the cloth will rise rapidly.

Example # 3: Heating a Semi-Transparent Plastic Sheet

A thermoforming process requires that 0.003 inch thick PVC be heated to 330° F. A 48 inch x 48 inch piece of material will be indexed between top and bottom heater banks, spaced six inches away. Our goal is to heat the plastic as efficiently as possible and determine the time required to do this.

1. Collect the data, make assumptions.
 - ΔT Plastic = 330° F - 60° F = 270° F
 - Specific heat plastic * = 0.25 BTU/lb° F
 - Weight of plastic * = 90 lb/ft³ X 1 ft³/1728 in³ X 0.003 inch thick = 0.000156 lb/in²
 - Heat up time = to be determined

Heat and Sensor recommends consulting NFPA Bulletin 56A from the National Fire Protection Association in Batterymarch, Massachusetts, for precautions in avoiding fire hazards, flammability and proximity hazards, and ventilation requirements.

*In addition to the above information, a transmission spectrum for PVC is needed.

Transmission Spectrum for Polyvinyl Chloride (Fig. 14)

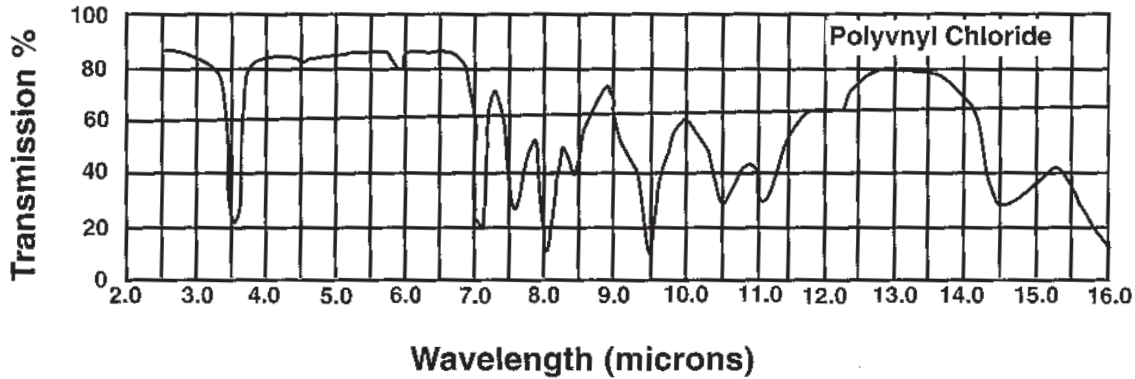

Absorption Bands = 3.2 to 3.6 microns, 6.8 to 12.5 microns

2. Determine the optimum heater temperature for most efficient heating of the pastic.

For maximum absorption, a heater temperature that corresponds to a peak energy wavelength of 3.4 microns is needed. Use Wien's Displacement Law to calculate this temperature, or see figure 4.

$$T = \frac{5269 \text{ }^\circ\text{R micron} - 460}{\text{Wavelength (microns)}}$$

$$T = \frac{5269 \text{ }^\circ\text{R micron} - 460}{3.4 \text{ microns}}$$

$$T = 1090^\circ\text{F}$$

In reality, tuning the heater to the proper wavelength is not that critical.

A heater operating in the range of 900-1300° F is acceptable. We choose to use a heater temperature of 1100° F.

3. Determine how much energy is delivered to the plastic with heaters operating at 1100° F.

A. Determine the view factor (F)

$$M = N = \frac{48}{6} = 8$$

From Figure 8:

$$F = 0.8$$

B. Calculate the effective emissivity

Emissivity of heater = $E_h = 0.85$

Emissivity of plastic = $E_p = 0.95$ (Most plastics reflect about 5%)

$$E = \frac{1}{\frac{1}{E_h} + \frac{1}{E_p} - 1} = \frac{1}{\frac{1}{0.85} + \frac{1}{0.95} - 1} = 0.81$$

C. Use the Stefan Boltzman equation or Figure 7 to determine radiated watts.

$$\text{Watts radiated to product} = \frac{S(\text{Th}^4 - \text{Tp}^4) \times E \times F}{144 \text{ in}^2/\text{ft}^2 \times 3.412 \text{ BTU/watt hr}}$$

$$\text{Th} = 1100^\circ\text{F} = 1560^\circ\text{R}$$

The average product temperature = Tp

$$\text{Tp} = \frac{\text{T(Final)} + \text{(T)Initial}}{2} = \frac{330 + 60}{2} = 195^\circ\text{F} = 655^\circ\text{R}$$

Plug the numbers into the equation or use Figure 7 to determine the Stefan-Boltzman component.

$$\text{Watts radiated to product} = \frac{S(1560^4 - 655^4) \times 0.81 \times 0.8}{144 \text{ in}^2/\text{ft}^2 \times 3.412 \text{ BTU/watt hr}}$$

$$\text{Watts radiated to product} = 20 \text{ W/in}^2 \times 0.81 \times 0.8$$

$$\text{Watts radiated to product} = 12.9 \text{ W/in}^2$$

We are heating from two sides so watts radiated to product, both sides = 25.9 W/in².

4. In Step 3, the wattage that penetrates the skin of the plastic sheet was calculated; but the absorption spectrum for PVC shows that most of this energy passes through the plastic without being absorbed. Using Figure 13, approximate how much of this energy is actually absorbed.

Absorption bands = 3.2 to 3.6, 6.8 to 11.5 microns

Heater temperature = 1100°F

Percentage of energy below 3.2 microns = 22%

Percentage of energy below 3.6 microns = 30%

Net energy in 3.2 to 3.6 micron band = 30 - 22 = 8%

Percentage of energy below 6.8 microns = 72%

Percentage of energy below 12.5 microns = 93%

Net energy in 6.8 to 11 micron band = 93 - 72 = 21%

Total in both bands = 8 + 21 = 29%

29% of the energy that penetrates will be absorbed.

The net energy absorbed = 25.9 W/in² x 0.29 = 7.5 W/in².

5. Determine the time required to heat the plastic.

$$\text{Watts} = \frac{\text{Weight} \times \text{Specific Heat} \times \text{Temperature Change}}{\text{Time (hrs)} \times 3.412 \text{ BTU/watt hr}}$$

$$\text{Time} = \frac{\text{Weight} \times \text{Specific Heat} \times \text{Temperature Change}}{\text{Watts} \times 3.412 \text{ BTU/watt hr}}$$

$$\text{Time} = \frac{0.000156 \text{ lb/in}^2 \times 0.25 \text{ BTU/lb}^\circ \text{ F} \times 270^\circ \text{ F}}{7.5 \text{ W/in}^2 \times 3.412 \text{ BTU/watt hr}}$$

$$\text{Time} = 0.000412 \text{ hours} = 1.5 \text{ seconds}$$

Comments/Questions

If only 29 percent (29%) of the energy is absorbed, what happens to the other 71 percent (71 %) of the energy that passes through the product?

In this application, most of it will be intercepted by the opposing heater, reabsorbed, and used to maintain the heater at 1100° F. Some of it is lost out the sides. (The view factor for the heaters, which are 12 inches apart, is $F = 0.6$) If heating from one side only, without a reflector on the unheated side of the material, then the energy that passes through the plastic would be lost.

What should the wattage of the heaters be?

The heaters must achieve 1100° F. If selecting Heat and Sensor Technology Panelmax 1330 panels, Figure 21 shows that a 23 W/in² panel will reach 1100° F in open air.

The actual wattage required in this application will be less, since the facing heaters will self-heat through the plastic; and the plastic is reflecting about five percent (5%) of the energy back into the heater. As the plastic heats up, it radiates back into the heater. A summation of all losses and the wattage into the load indicates a minimum heater wattage of about 15 W/in². A safety factor of 1.25 would put the heaters at about 19 W/in².

What if we want to heat the plastic faster than 1.5 seconds?

Running the heater at a higher temperature will produce more energy at the desired wavelengths, so it will heat the plastic faster. A substantially higher temperature will also result in a greater percentage of energy in the shorter wavelengths that the plastic does not absorb, so a greater percentage of the energy may be wasted (depending on oven design).

There is also a limit to the amount of energy that can be absorbed on the surface without blistering. This depends on the plastic thickness and whether it absorbs on the surface or volumetrically. Fillers and pigments can dramatically improve the absorptivity of plastics. It is desirable to have an absorption spectrum for the actual product and thickness being heated, not just the pure plastic type.

Note: The efficiency of an IR oven depends on the oven design. If heating from one side only without a reflector or another heater to capture and reflect the energy back to the plastics, the energy that passes through is lost. If facing heaters and side reflectors are used the efficiency can be quite high, even when heating transparent materials.

Controlling Radiant Heaters

The following examples of radiant control systems will suggest possible control configurations for your application. The components of a control system are:

- Temperature controls
- Temperature sensors, contact or non-contact
- Power switching devices

No Control

In some simple, undemanding applications, it is possible to design radiant heaters that operate uncontrolled. In these situations, the heaters simply operate full **ON** all the time. The heaters must be conservatively rated so that in all circumstances that might occur in the application the heaters do not exceed their maximum safe operating temperature.

The amount of heat absorbed by the product can be controlled by adjusting the time the product is under the heater. The heat absorption can be moderated somewhat by adjusting the distance between the heater and product. Moving the heater farther from the product will reduce efficiency and temperature uniformity around the edges.

Percentage Power Control Without Temperature Sensing (Open Loop)

Percentage power control devices are sometimes called rheostats, percentage timers, or variacs. They may adjust the voltage supplied to the heater or they may turn the heater **ON** and **OFF**. For example, a percentage timer with a 10 second cycle time, if set to 50 percent (50%) power, would have the heater **ON** for five seconds and **OFF** for five seconds.

Percentage power controls result in an open loop control system, since the heater or product temperature is not sensed. It is simply a means of adjusting the percentage of available power supplied to the heater. When the input power is adjusted down, the heater operates at a corresponding lower temperature and power output.

Percentage power control is better than no control in that the heater does not have to be designed at exactly the correct wattage to work in the application; there is adjustment. They work best when the application presents a continuous unchanging heat load. Since there is no temperature sensing and no feedback, the system cannot adjust to any changes.

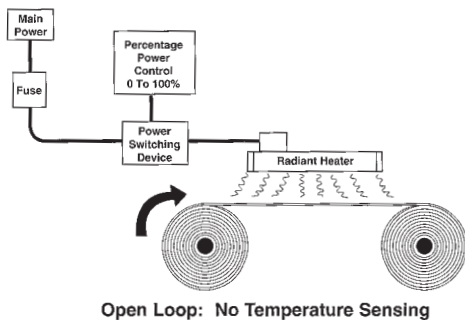

Note: Heat and Sensor always recommends the use of a separate high limit control device that will cut the power to the system in the event of overtemperature conditions.

Control system components are available from Heat and Sensor Technology and are described in depth in both catalogs. Your local Heat and Sensor representative is ready to help you design a radiant control system to meet your application needs.

For example, consider a radiant oven in which a web of material is being moved between two facing panel heaters. Suppose the web of material breaks, leaving the heaters facing each other with no material to absorb the heat. The heaters will self-heat and could reach a temperature high enough to destroy themselves.

With an open loop control system, worse case condition must be carefully considered so that the heaters do not damage themselves or the product.

Sensing and Controlling the Heater Temperature (Closed Loop)

In a closed loop system, the temperature of some location in the system is sensed; and a controller adjusts the power supplied to the heater to maintain a pre-set temperature.

Ideally, the temperature of the product could be sensed; and the controller adjusts the power supplied to the heaters to achieve the desired product temperature. In most radiant applications, it is difficult to accurately sense the product temperature by physically contacting it with a sensor, such as a thermocouple.

In most radiant applications, a thermocouple is used to sense the heater temperature, and this temperature is controlled so that the product leaves the oven at the desired temperature. The operating temperature of the heaters is normally much higher than the desired product temperature.

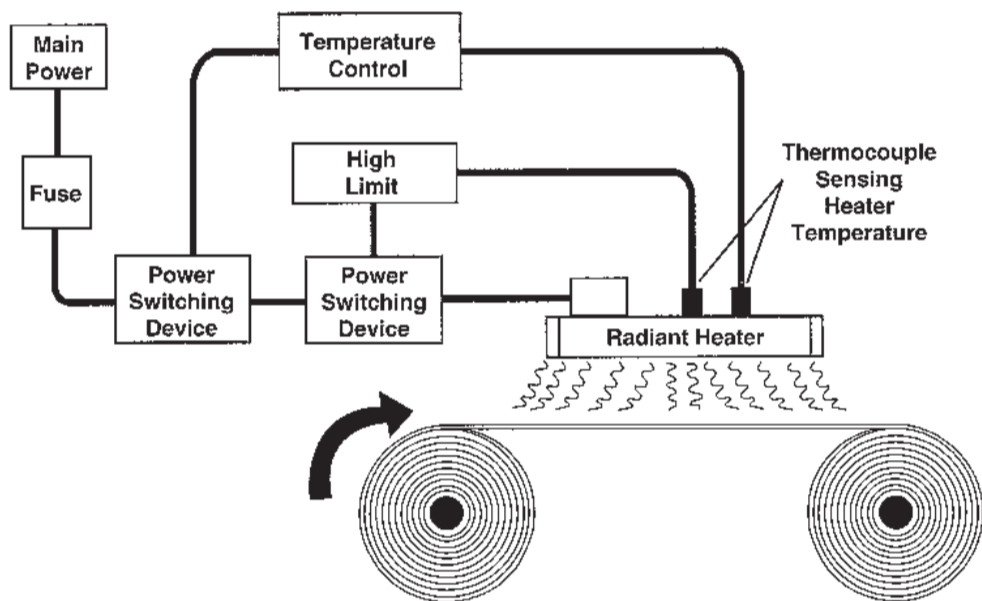

Closed Loop: Heater Temperature Sensed and Controlled

For example, consider a web of material being pulled between two facing radiant heaters. Once the speed of the material is established, the temperature of the heaters is adjusted so that the web reaches the desired temperature. A 300°F web temperature might require the heaters to be operated at 900° F. If the web breaks so that the radiant heaters are left facing each other with no material between them, there is no danger of overheating the radiant panels. The control maintains their temperature at 900° F. It is interesting to note that when there is no material between the heaters, there is very little power used to maintain their 900° F temperature.

Many people building radiant ovens for the first time try to locate their temperature sensor in the air somewhere between the heater face and the product. In this case, the sensor is measuring some combination of the

ambient air temperature and the radiant energy intercepted .

Usually this sensor temperature does not correspond closely to the product temperature, nor does it provide adequate over-temperature protection for the heaters. It responds very slowly to changes in the system. Sensing the heater temperature is usually a much better approach.

When a large array of panels is being controlled, it is possible to control a group of heaters (or zones) with one control and one thermocouple input. In this case it is wise to choose a thermocouple location that will see the highest heater temperature in that zone. For example, if one intends to control horizontal facing heaters with a single sensor input, it is best to place the sensor in the top heater, since convection causes the top heater to run hotter. In a long conveyor oven, the sensor should be located near the end of the oven, since, as the product gets hotter as it travels through the oven, it radiates more energy back into the heaters causing them to run hotter.

Sensing the Product Temperature With an IR Sensor

Ideally, the radiant oven user could set a knob to the desired product temperature, and the product would come out of the radiant oven at this temperature.

To accomplish this, the product temperature must be sensed; and this value is then used to control either the heater temperatures or the time spent by the product under the radiant heaters.

In most radiant heating applications, it is usually impractical to try to sense the product temperature by physically contacting it, such as with a thermocouple.

An infrared sensor can measure the product temperature without contact by measuring the infrared radiation it gives off. A control then uses this information to adjust either the heater temperature or the speed of the product

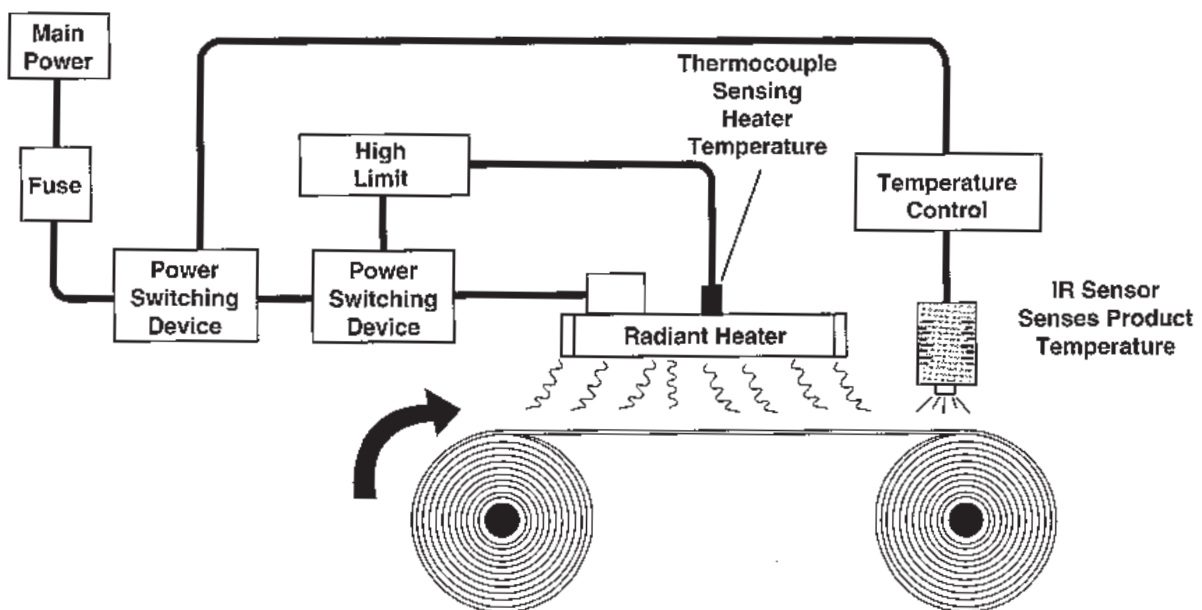

Product Temperature Sensed and Used to Control Heater Temperature

through the oven to achieve the desired product temperature.

When an infrared sensor is used to sense the product temperature, it is still important to sense the heater temperature and control this temperature so that the heaters are not operated above their maximum safe temperature. The infrared sensor control circuit is only measuring the product temperature and does not provide any protection to the heaters, if, for example, there is no material in the oven. When the infrared sensor is used to control the heater temperature, a separate high limit device can be used to cut off the power to the heaters if they get too hot.

When the infrared sensor is controlling product speed through the oven, then a standard temperature control is used to maintain the heater temperature.

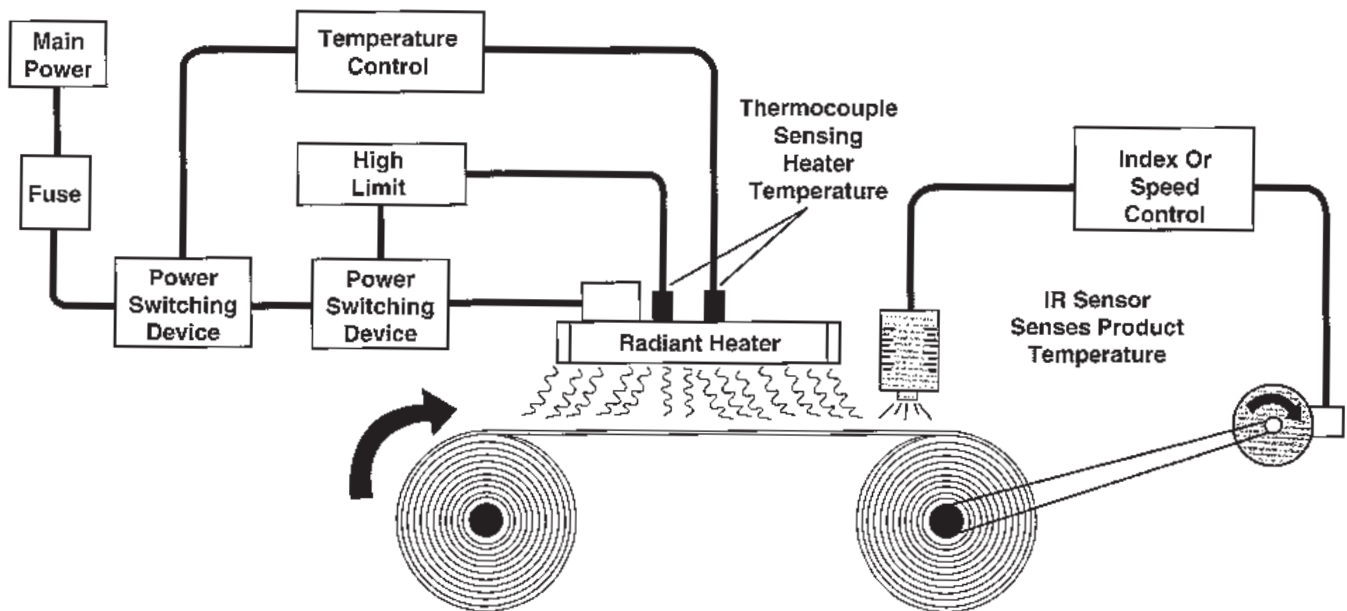

**Product Temperature Sensed and Used to Control Product Speed.
Heater Temperature Controlled Separately.**

Tips On Oven Design

Efficiency

The efficiency of a radiant oven depends heavily on how it is designed. The emissivity of the product determines the amount of incident energy that is absorbed. A product with an emissivity of 0.5 will absorb only 50 percent (50%) of the energy that hits it. The balance will be reflected or transmitted. Proper oven design will prevent most of this energy from being lost.

Ideally, the oven will be a light tight box, with all surfaces being reflective except the product and the heater. Stray radiant energy will bounce off the reflective surfaces of the box until being absorbed by the heater or the product. A layer of insulation on the outside will help to reduce convection losses.

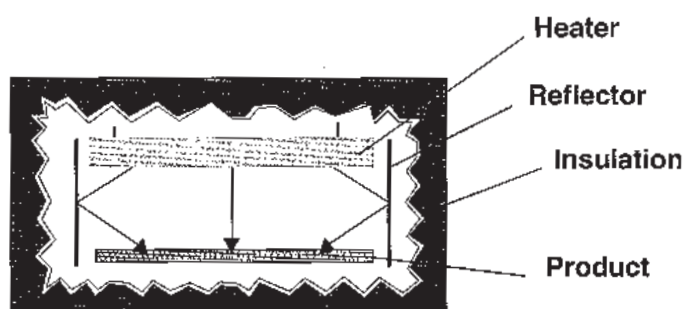

Opaque/Reflective Product

Reflective sides of polished metal will help direct edge losses back onto the product and reflected energy back into the heater for re-radiation.

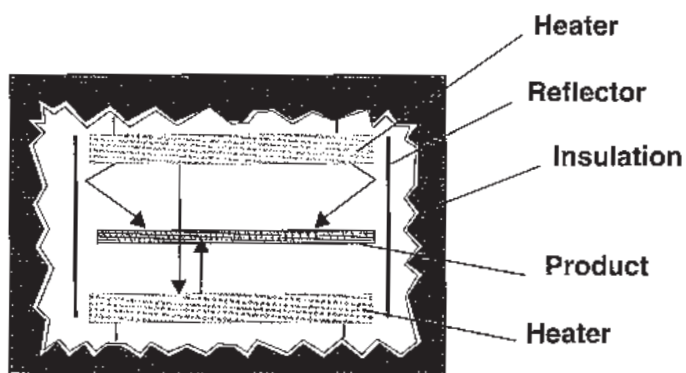

Transmissive Product

A reflector behind or below the product, along with reflective sides will redirect transmitted energy back up through the product and back into the heater for re-radiation.

Heaters on both sides of the product will absorb and re-radiate transmitted energy.

Dealing With Line Stoppage

If the product should stop while exposed to the radiant heaters for too long a time, the product, and possibly even the heaters, could be overheated. Even if the power is cut when the line stops, residual heat in the heaters may cause damage to the product. Cool down rates for each of the Panelmax heaters is given in the Heater Specifications section, of this booklet on pages 34-37. Radiated energy depends on T^4 , and the graphs show representative energies at several temperatures. It is the radiated energy that the product sees, not the heater temperature .

If it is determined that residual heat could harm the product during line stoppage, any one or more of the following methods could be employed to protect the product:

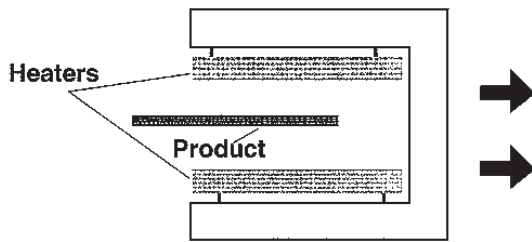

Retract the Heaters

Heaters can be pulled back, rotated, or moved to the side to direct the radiant energy away from the product. Retracting mechanisms should not shock or vibrate the heaters when they reach the end of their travel. Repeated vibration may result in shorter heater life.

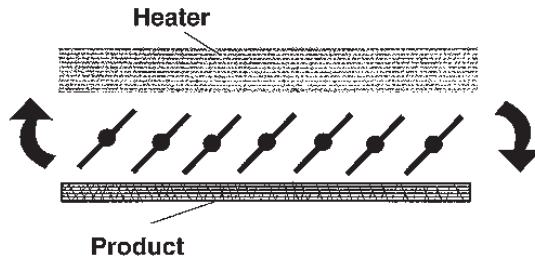

Shield the Product

Shutters or shields can be rotated or slid into place to block the residual radiant energy from reaching the product. Shutters must be able to withstand the oven temperature and still operate reliably.

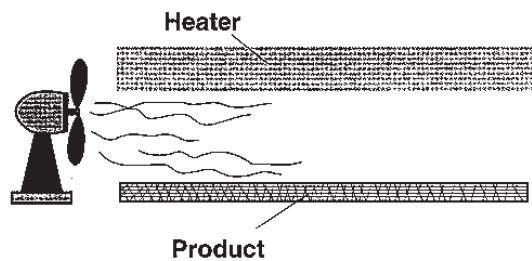

Cool Air Purge

Room temperature air can be blown through the oven to cool the heaters and the product.

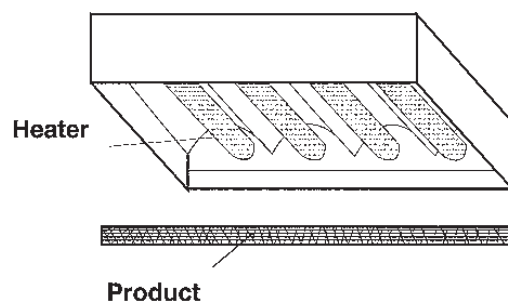

Quartz Tube Heaters

Quartz tube heaters are not as uniform or rugged as panel heaters but they will cool down to a safe temperature in about 30 seconds. Heat and Sensor Technology manufactures several types of quartz tube heaters.

Heater power must be turned off immediately during any of these operations. The control system should automatically perform this task when the product motion stops.

Temperature Uniformity: Edge Losses

The radiant energy density at the edge of a radiant panel is always less than the energy density under its center. If the product is the same size as the heater, the center of the product will get hotter than the edges. There are three methods available to moderate this edge loss effect:

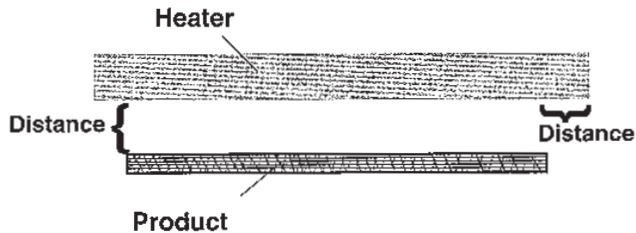

Heater Overlap

In an open sided oven, uniform heating can be improved if the heater overlaps the product by an amount equal to the distance from the heater to the product.

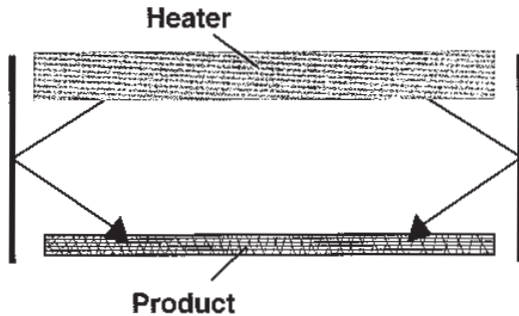

Reflective Sides

Polished metal sides will help direct edge loss energy back onto the product.

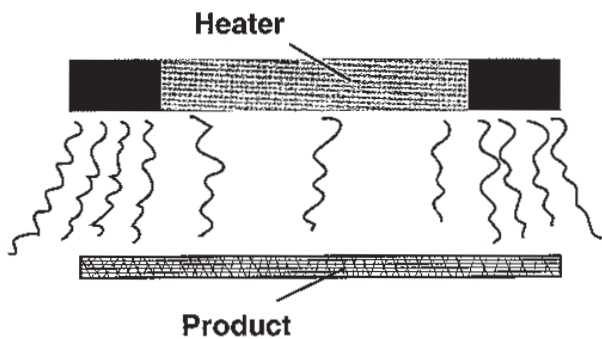

Distributed Wattage

Higher watt density (usually 20 to 50%) or separate control zones on the sides of the oven can boost the power density in these areas to make up for edge losses.

Temperature Uniformity: No Heat Areas

All radiant heaters have areas across their surfaces or at the edges where the energy output drops below the normal average energy uniformity. The most typical locations are at the sides and ends (especially the ends, since bussing and lead connections must be made in these areas).

When heaters are grouped together to build up larger arrays, it is important to be aware of the no-heat areas and how they will combine in the final configuration. The approximate sizes of unheated areas for each of the Panelmax panel types is given in the Specification Section. If the product is a continuously moving web; an unheated area that completely spans the web perpendicular to the direction of travel, will not affect uniform heating.

Some methods of grouping heaters to reduce the effects of no-heat zones are given below.

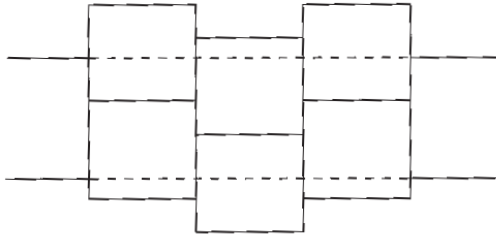

Staggered Units

By shifting alternate units a few inches sideways, the no-heat between units can be spread out and its effects reduced in magnitude. (All units are the same.)

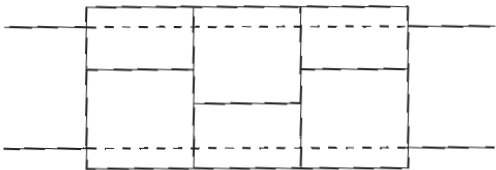

Alternate Size Units

Combinations of long and short units can be used to spread out the effects of the no-heat area. A minimum of two designs are required.

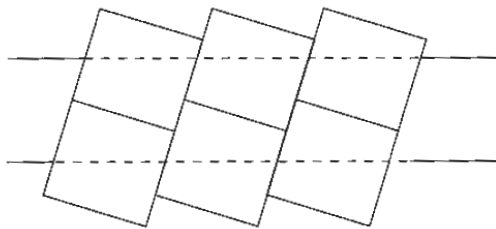

Diagonal Positioning

By setting all units in the assembly at an angle, as shown, the gap between heaters is shifted across a greater width, relative to the product flow. This reduces the differential heating in that area.

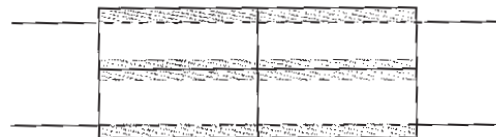

Zoning

The shaded areas represent where the extra power could be applied to offset the edge losses and nonuniformity at the center. The heaters must be built with special higher watt densities or separate control zones in these areas. The size of zoned area and the higher power differential

Mounting

Panel heaters are available with threaded studs welded to the back sheet metal for mounting purposes. The studs are typically located approximately on 12 inch centers.

All metal cased radiant heaters expand as they heat up, and room must be provided at the ends and sides of the unit for about one percent (1%) growth. Holes for mounting studs must be oversized or slotted. The mounting studs must be free to move in the oversized hole. On long units, if the studs are tightened firmly to the mounting frame, either the panel will warp or the studs will be bent.

Note: The spacing between source and load can also affect uniformity. Generally, the closer the heater is to the load, the more pronounced will be the effects of heater nonuniformity. Increased distance allows the radiant energy to “spread” and become less focused, but at the possible loss of efficiency due to greater edge losses.

Wiring

Do not use copper wire or ring terminals when wiring radiant heaters. Backside temperatures can reach 500° F or higher in enclosed ovens. Use nickel or nickel clad wire of the proper size and derated for the ambient temperatures. Heaters should be properly grounded.

Contamination

Some constructions are contamination resistant. Other heaters will be damaged by contaminants. When drilling holes in the mounting frame work, the heaters must be protected from metal shavings.

Vibration

Continuous vibration will break down the electrical insulation in most heater constructions. Consult Heat and Sensor. If the heaters are indexed back and forth, they must not slam to a stop when they reach the end of their travel. Dampers or shock absorbers should be used to bring the heaters to a gentle stop.

Conclusion

Radiant heating with infrared can be a powerful production tool that speeds up processes, improves quality and reduces energy consumption. Successful radiant systems can be designed by understanding the physical elements involved i.e., radiated power, view factor and emissivity. Good results require reasonably accurate values for material emissivities, mass, and specific heat. Run test when possible.

Heater Specifications

Panelmax 1010

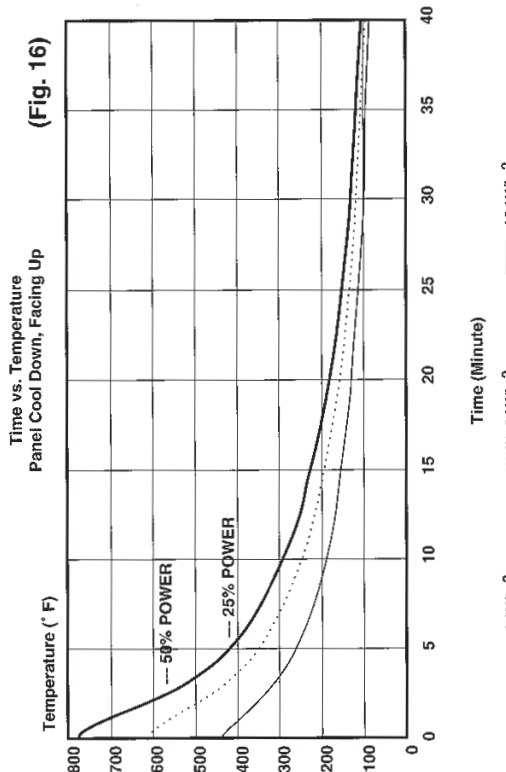
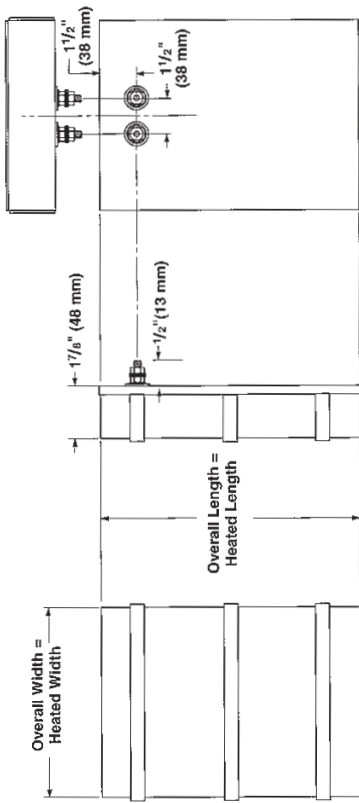
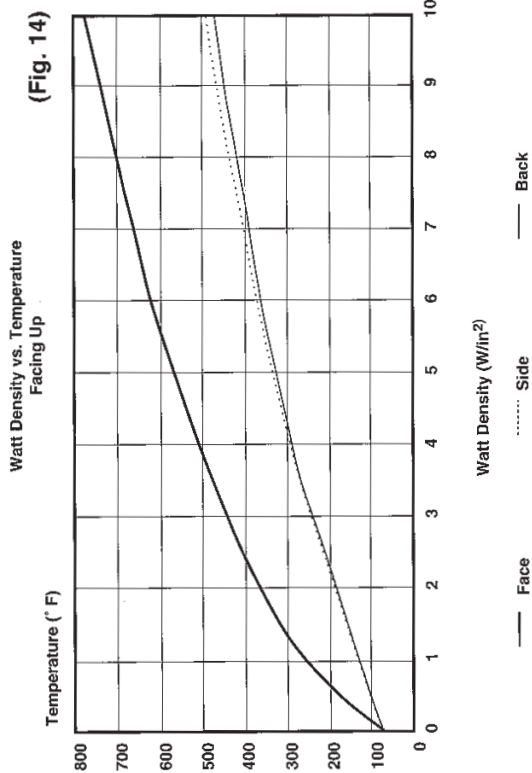
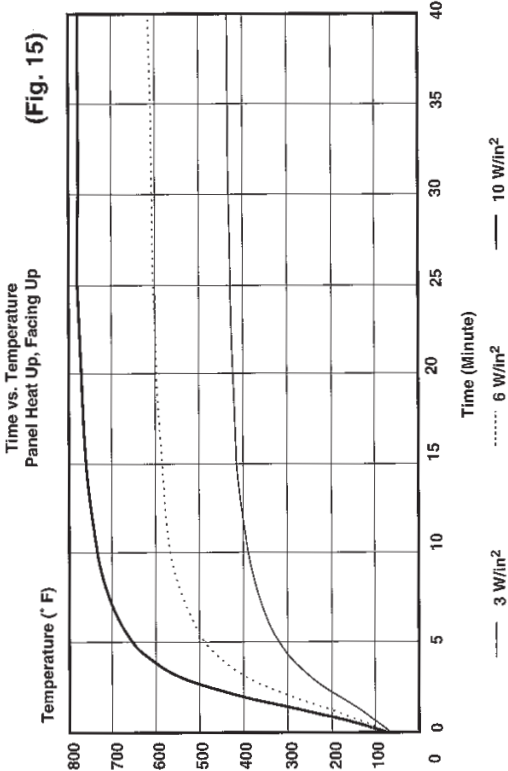

Panelmax 1120

Watt Density vs. Temperature Facing Up

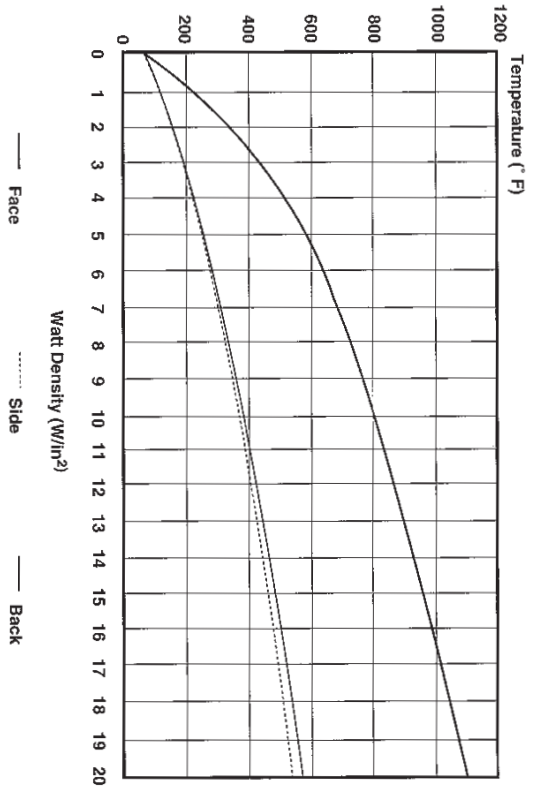

(Fig. 17)

Time vs. Temperature Panel Heat Up, Facing Up

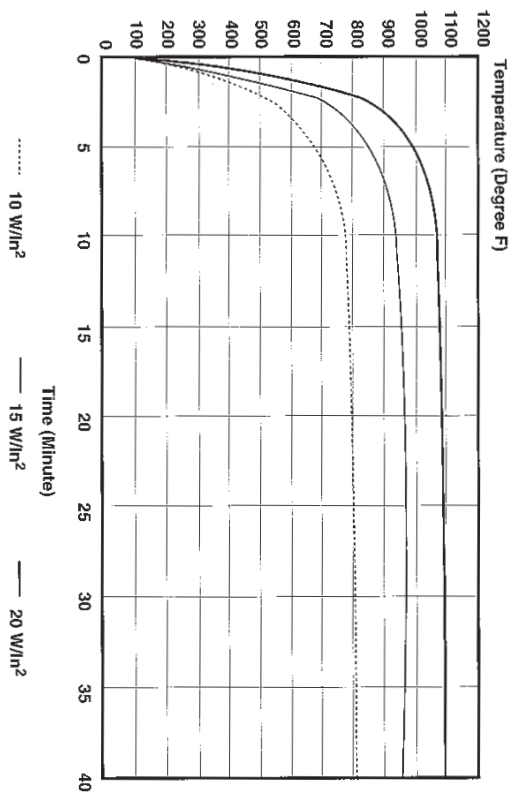

(Fig. 18)

Time vs. Temperature Panel Cool Down, Facing Up

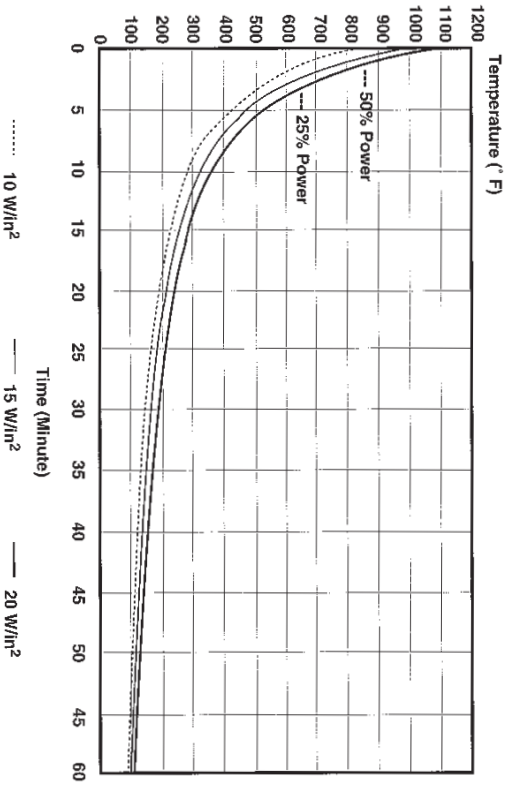

(Fig. 19)

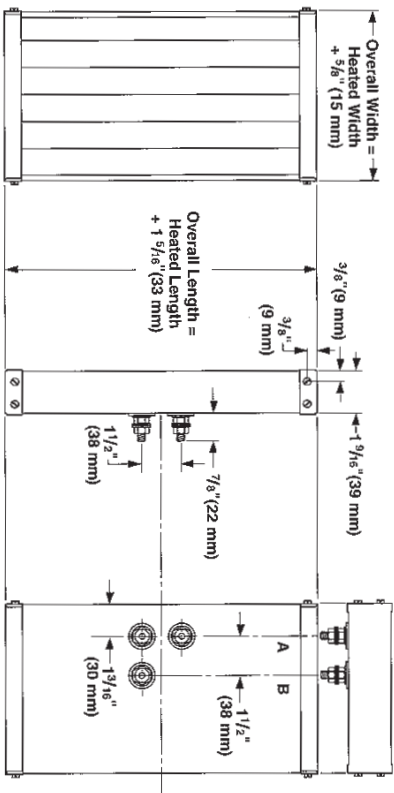

Panelmax 1330

