

PUR-Therm™ Gas Delivery Heater

New Product
Preview



PUR-Therm gas delivery heaters from CAS are designed to heat critical carrier gases and process gases. Manufactured to meet the industry's stringent purity standards, PUR-Therm gives OEMs and fabricators a more efficient, more accurate method of heating chamber gases, without sacrificing purity.

- PUR-Therm delivers more accurate temperature control, compared to heaters that 'wrap around the gas line'
- PUR-Therm eliminates the messy wires & control mechanisms associated with flexible gasline heaters
- PUR-Therm can be easily installed into gas cabinets or integrated 'in-line' at any point along the gas stream
- PUR-Therm is compatible with most standard controls
- PUR-Therm complies with a comprehensive array of industry standards for High Purity and Ultra High Purity

And PUR-Therm utilizes the benefits of cast-in components to deliver more heat at lower wattages. Compared to other heaters, PUR-Therm uses less energy to achieve the same Delta-T.

APPLICATIONS:

- Carrier Gas Heating
- Process Gas Heating
- Air & Nitrogen Heating for Wafer Drying

Indirect Heat: heated gases are isolated in high purity 316 seamless stainless steel flow-tube, never contacting the heating elements or any other heater components.

CLEAN & PURE FLOW-TUBE

- Particle Test: Meets Semi F-70 "Ultra-High Purity" spec
- Roughness (Ra): Meets Semi F-19 "Ultra-High Purity" spec
Average Ra: 2.53 μin (0.064262 μm)
Maximum Ra: 3.19 μin (0.081026 μm)
- Bend Radius: Complies with Semi E49 Guidelines for Inert and Reactive Gases (5 x Radius)
- Passivated to ASTM-967 specs

POWERFUL & ACCURATE HEAT

- Max Operating Temperature to 300°C (572°F)
- Standard Power: 208 Volt single phase, 400 Watts
- Replaceable Heating Element
- Dual Sensor Thermocouple: for accurate control of operating temps and secure over-temp protection

EASILY INTEGRATED

- Industry-Standard Gasline Flow-Tube Size:
1/4" (6.3 mm) OD, .035 Wall (.89 mm)
- Industry-Standard VCR Fittings (certified Ultra-High Purity) on Tube Inlet & Outlet

COMPACT & SAFE

- Body Dimensions: 3.50" (89 mm) x 3.75" (95 mm)
- Optional Insulating Jacket (Semi-S2 Compliant)

PUR-Therm™ Gas Delivery Heater: High-Purity

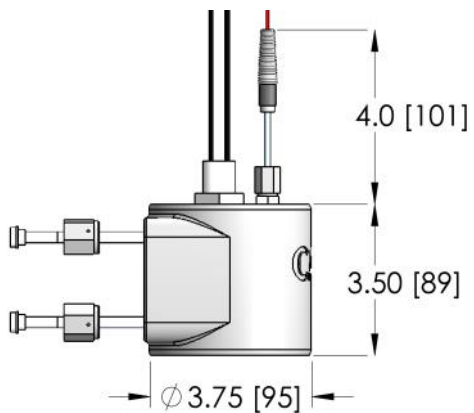

Side View

Small Footprint for Easy Integration
Heater body height & diameter less than 4" [100 mm]

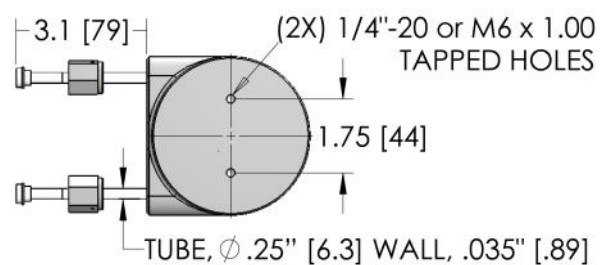

Bottom View

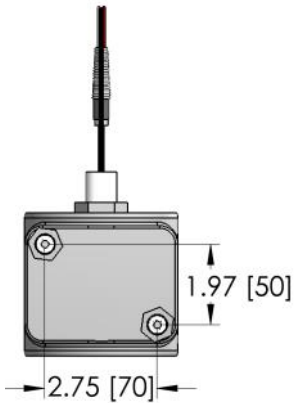

Front View

PUR-Therm Heating Profile: Delta T using Nitrogen

Process Fluid = Nitrogen @ 30 psi (206 kPa) (2.06 Bar), Average Inlet Temp = 20.91°C (69°F), Single Pass*

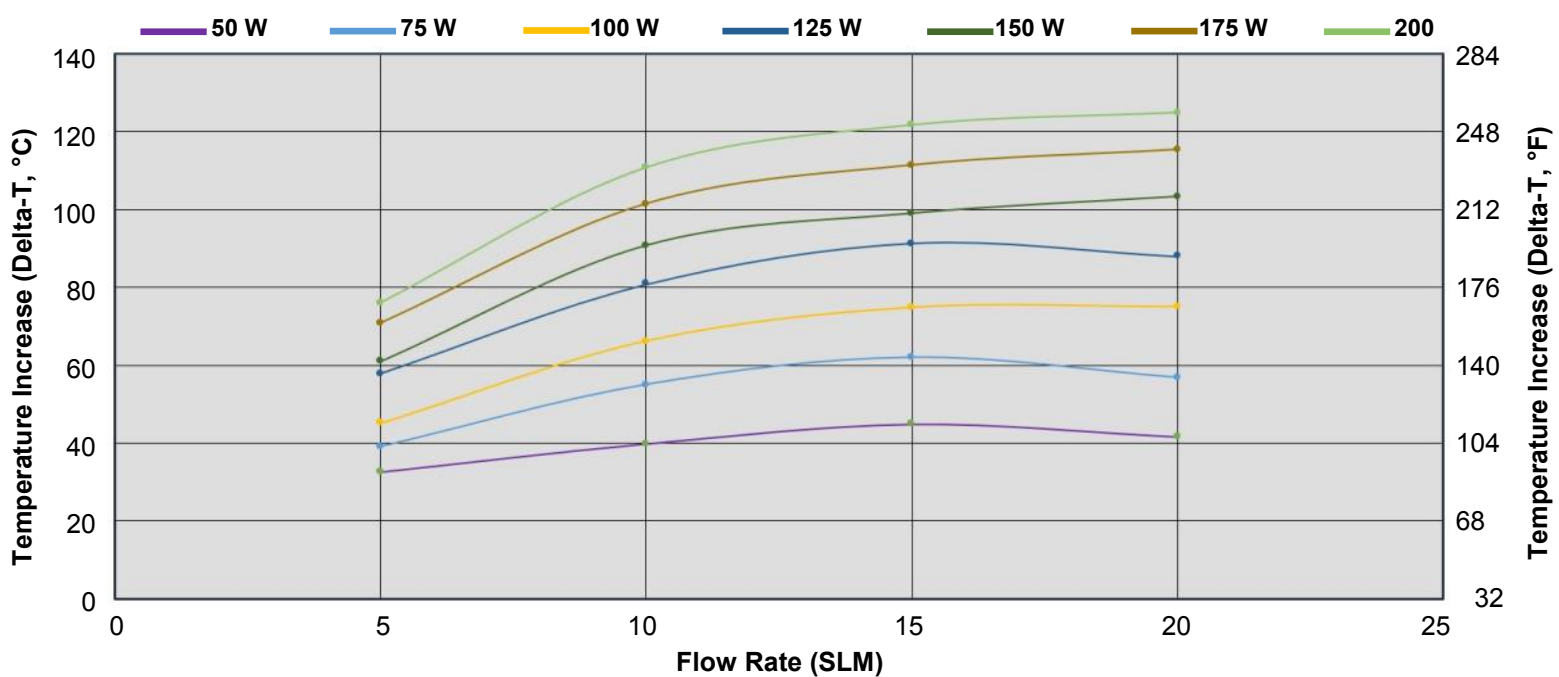

*Outlet Pressure Drop for PUR-Therm is Minimal: <2 PSI for All Above Tests

More Than Enough Power

PUR-Therm is configured specifically for heating process & carrier gases.

Given These Typical Specs for Carrier/Process Gas Heating...

- Test Media: Nitrogen
- Flowrate: 20 SLM Max.
- Inlet Temp: 20°C
- Outlet Temp: 140°C
- Delta-T: 120°C

...Approximate Required Watts Would Be: 100 W

PUR-Therm is equipped with a 400 Watt element.

So if your process has higher flowrates or temperature requirements, PUR-Therm has more than enough power.

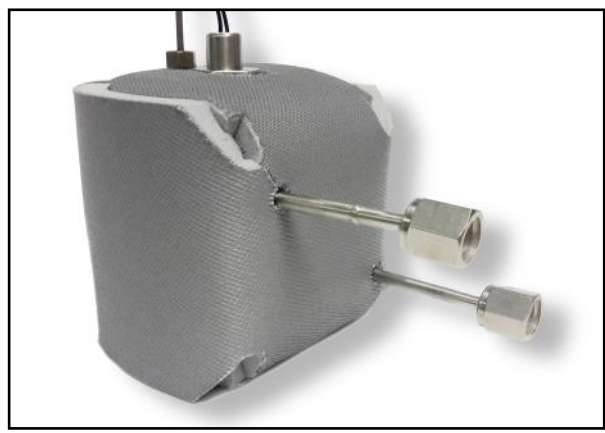

Semi S2 Touch-Safe Insulating Jacket
PUR-Therm is available with a custom-fit insulation jacket made from high-temp materials.

Heating of Carrier Gases & Process Gases

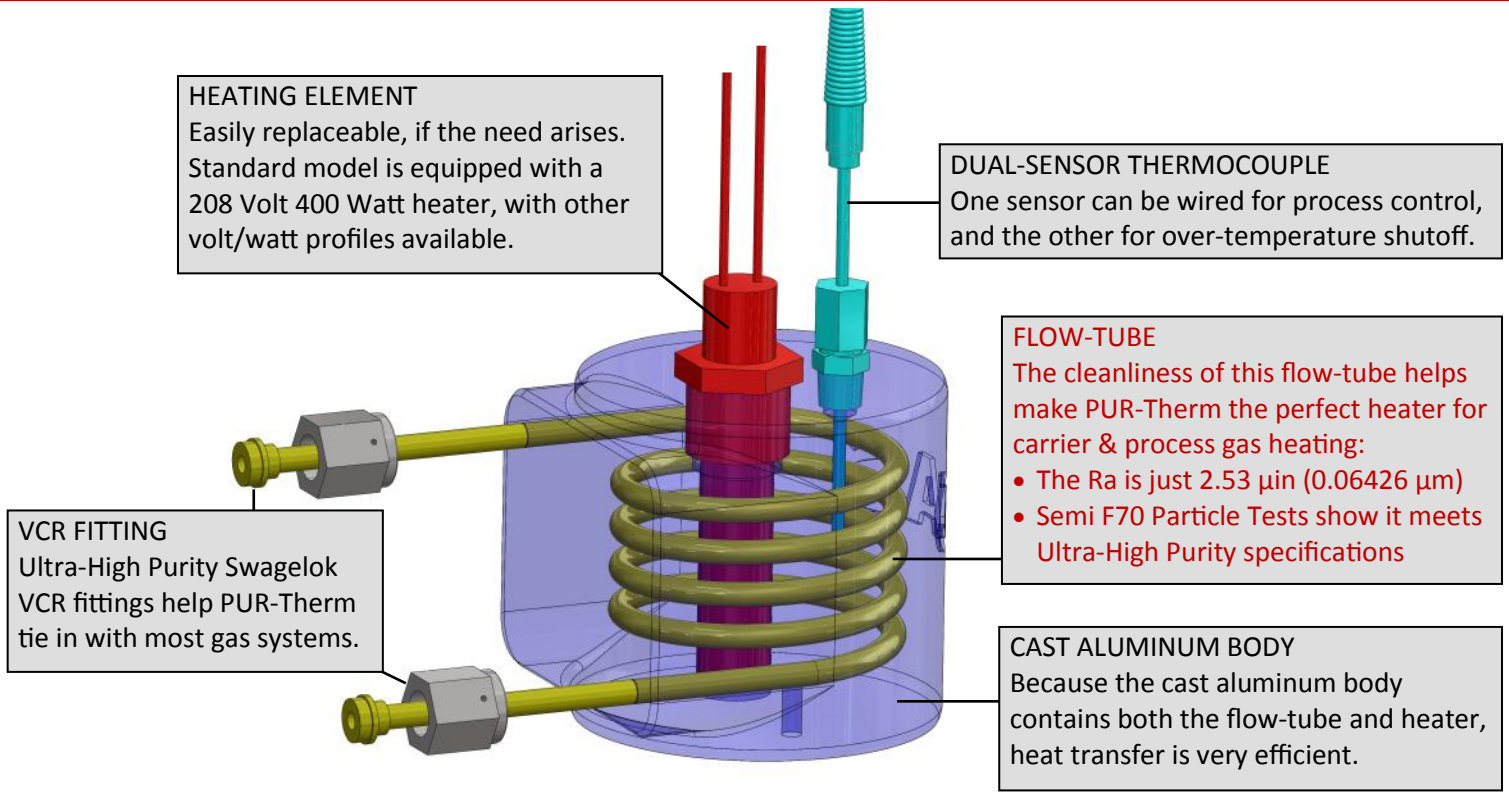

Flow-Tube Purity: Tested and Proven

CAS understands the importance of testing and verifying cleanliness.

Tests have been performed on completed PUR-Therm Heaters as well as individual flow-tube assemblies.

Particle Testing - DUT
6-28-2017

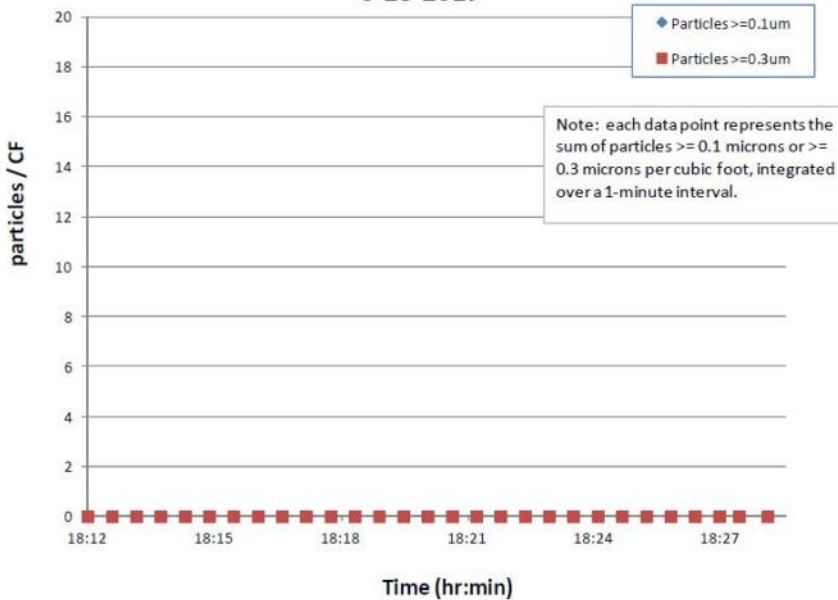

Semi F70 Particle Testing

Graph shows data gathered after 20 minute purge process.

No particles were found, monitoring for $\geq 0.3\mu\text{m}$ and $\geq 0.1\mu\text{m}$ size particles.

These results classify PUR-Therm in the F70 test's Ultra-High Purity category.

Semi F70-0611 (Table R1-1) Static Flow Particle Test for a weldment manifold.

Test provided by independent lab, certified by the American Assoc. of Laboratory Accreditation.

Sample ID	Location	R _a (μin)	R _a (μm)
Electro-polished Stainless Steel Tube for PUR-Therm Gas Heater	1	2.17	0.055118
	2	2.72	0.069088
	3	3.19	0.081026
	4	2.28	0.057912
	5	2.27	0.057658
	Average	2.53	0.064262
Semi F19 Standard for UHP		$\leq 5 \mu\text{in}$	$\leq 0.13 \mu\text{m}$

Surface Roughness Testing

Graph shows Ra data across 5 locations.

According to the Semi F19 Ra specification for High Purity and Ultra-High Purity, **PUR-Therm's tube meets the Ultra-High Purity standard.**

Profilometry analysis determined by ANSI/ASME B46.1

Test provided by independent lab with multiple certifications.

With PUR-Therm Heaters, Purity Starts with the Tube

CAS purchases industry leading High Purity and Ultra-High Purity tubing for use in PUR-Therm. These are a few of the critical quality and purity-related tests performed by the tube manufacturer.

PRECISE METALLURGIC COMPOSITION & INITIAL MANUFACTURING

- Tubing is produced from TP 316L stainless steel raw material, conforming with ASTM A632. Tubing is seamless.
- Tubing has a sulfur range of 0.005 to 0.012%
- Tubing is bright annealed in dry hydrogen atmosphere (dew point $\leq -40^{\circ}\text{C}$), or vacuum annealed (10 micron Hg)

LOW RA ELECTROPOLISHING

- Tubing is electropolished using automated equipment to uniformly monitor & control all major variables.
- Tube's finished ID must have an average Ra of 5 μin (0.1270000 μm) maximum.

EXTREMELY-THOROUGH PASSIVATING

- Tubes are passivated for 30 minutes minimum, then rinsed with filtered DI water.
- Final rinse is in ISO Class 4 cleanroom; tubes are rinsed with 0.1 micron filtered, 18 megohm-cm DI water, heated to 60°C . Rinsing continues until effluent resistivity measures a minimum of 17.5 megohm-cm.
- After final DI rinsing, tubes are dried using UHP nitrogen filtered to 0.005 micron.

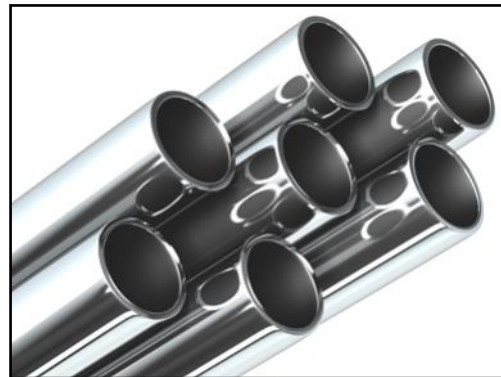

MULTIPLE DEEP-ANALYSIS TESTS

- **Particle Testing**
Must show less than 10 particles ≥ 0.1 micron per cubic foot, and no particles ≥ 0.3 per cubic foot
- **SEM (Scanning Electron Microscopy) Analysis** is performed in compliance with SEMATECH 90120401B
Must show no more than 40 distinguishable pits, inclusions, or other raw material defects at 3500 X magnification.
- **XPS Analysis** (X-Ray Photoelectron Spectroscopy) is performed in compliance with SEMATECH 90120403B
Must verify a minimum chromium to iron ratio of 1.5:1 and a minimum chromium-oxide to iron-oxide ratio of 3:1
- **AES Analysis** (Auger Electron Spectroscopy) is performed in compliance with SEMATECH 91060573B
The level of acceptability is a mean oxide layer thickness of 20 Angstroms

Cast Aluminum Solutions designs and manufactures precision-engineered thermal components for semiconductor machine OEMs and fabricators worldwide. CAS is a leader in 200 & 300 mm Pedestal Heaters, and we offer an array of Circulation Heaters for liquids & gases, including CAST-X Circulation Heaters, PUR-X PFA Tube Heaters, and our new PUR-Therm Gas Delivery Heaters.

Customers view CAS as "an extension of their engineering team" due to the relationships we build in developing, testing and manufacturing key components. Our list of innovations includes platens with both heating and cooling capabilities, several innovative 450 mm chucks, and our CAST-X High-Temp Circulation Heaters, capable of heating liquids & gases to 600°C .

In addition to 3-D structural modeling and FEA (finite element analysis) thermal modeling, our in-house test lab includes infrared thermal imaging, X-Ray & ultrasound technology, vacuum chamber testing, lifecycle testing and more. The CAS manufacturing facility features the latest pressure-casting technology, advanced CNC machining & finishing, and cleanroom assembly facilities.

Contact CAS to get started on your precision-engineered project: CAS has engineers throughout the Americas, Europe and Asia.



SOUTHEAST THERMAL SYSTEMS

WWW.SETHERMAL.COM

RFQ@SETHERMAL.COM

PHONE: 704-399-4248

PUR-Therm Gas Delivery Heater

Part Numbering Tables

1-2019

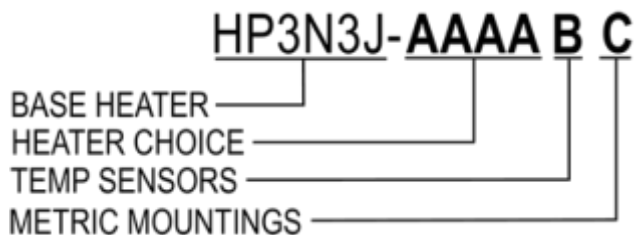
**BASE HEATER BODY****Includes the following features:**

- High-Purity Flow-tube: 1/4" (6.3 mm) OD with .035 (.89 mm) Wall
- Flow-Tube is Electropolished to 2.53 µin (0.064262 µm)
- Flow-Tube is Passivated to ASTM-967 spec, after all manufacturing processes are complete
- VCR Fittings are Orbitally-Welded onto the Entry & Exit of Flow-tube

VOLTAGE, POWER, CIRCUIT TYPE*Volts refers to line volts (VL). Amps refers to line current (IL).*

Section "AAAA"	Circuit Type (all are single circuit)	Volts (V)	Watts (W)	Amps (A)
100A	SINGLE PHASE	240	530	2.2
		208	400	1.9
		120	130	1.1
100B	SINGLE PHASE	240	1330	5.5
		208	1000	4.8
		120	330	2.8

TEMPERATURE SENSORS*All thermocouples are ungrounded, for optimal performance.**All below options are included in price of heater.*

Section "B"	Description	No. of Sensors
1	DUAL J-TYPE THERMOCOUPLE IN THERMOWELL	1 probe, 2 sets of wires
2	DUAL K-TYPE THERMOCOUPLE IN THERMOWELL	1 probe, 2 sets of wires
3	RTD, SINGLE, 3 WIRES, 100 OHM IN THERMOWELL	1 sensor

METRIC MOUNTING HOLES*Place an "M" in section C if metric mounting holes are required. If standard Imperial mounting holes are desired, leave section D blank.*

Section "C"	Metric Mounting Holes
M	M8 X 1.25 METRIC TAPPED MOUNTING HOLES

ACCESSORIES*These PNs are totally separate from the PNs for the heater*

Part Number	Component
307-0-31-1	INSULATION JACKET, MAXIMUM TEMPERATURE 400°F (204°C)